

Singer 42-2

Singer 42-3

Singer 42-4

Singer 42-5

Singer 42-8

**Price List of Parts**

**Numbers**

**42-2**

**42-3**

**42-4**

**42-5**

**42-8**

**MACHINES.**



**THE SINGER MANUFACTURING COMPANY.**

## INDEX.

	PAGE
No 42-2 Machine.....	4
“ 42-3 “ .....	8
“ 42-4 “ .....	9
“ 42-5 “ .....	13
“ 42-8 “ .....	17
Accessories.....	18
Bobbin Winders .....	19
Knee Lifter (Power Table).....	19
“ “ (Stand).....	21
Numerical List .....	25
Obsolete Parts.....	22
Stand Parts.....	22

## List of Parts

### NUMBERS

# 42-2, 42-3, 42-4, 42-5 and 42-8

### MACHINES.

In ordering from this list, use **ONLY** the **PART** number, in the first column.

Each number always indicates the **SAME PART** in whatever list it appears, or for whatever machine

The letters after some of the numbers indicate the style of finish only, as follows :

- A.** Hardened, Polished and Plated.
- B.** Polished and Plated.
- C.** Hardened only.
- D.** Polished “
- E.** Soft, not Polished.

These letters **MUST BE USED** *when* they appear in the list, and **AFTER** the number, *as* in the list.

In this series

1 to 1500 are Screw Numbers.

1501 “ 1800 “ Nut “

1801 “ 2000 “ Roller “

2001 and upward are numbers of Machine Parts.

The figures in the second column refer only to the plates, illustrating the parts, and are **NOT TO BE USED** in ordering.

Parts marked with an asterisk (\*) are furnished only when repairs are made at factory.

### 42-2 MACHINE.

C. B. DROP FEED, BOTH SIDES OF NEEDLE, HINGED PRESSER FOOT, LINK NEEDLE BAR CONNECTION, CLOTH.

No.	Plate	Name.	Each
*4287	—	Arm.....	4 50
2002	686	" Dowel Pin.....	02
4448	695	" Oil Tube for intermediate bearing.....	06
123E	691	" Screw.....	06
6109	696	" Shaft for 3011.....	1 50
6107	696	" " " 5977.....	1 50
3005	678	" " Bushing (back).....	25
448c	691	" " " " Set Screw.....	03
*4449	—	" " " (front).....	30
144D	691	" " Screw.....	12
4288	678	" Side Cover.....	10
286D	692	" " Thumb Screw.....	08
5811	695	" Spool Pin and Thread Eyelet.....	05
3011	696	Balance Wheel (two-speed) for 6109 with two 448c.....	1 75
5977	696	Balance Wheel (two-speed) for Loose Wheel Attachment 5981.....	1 75
448c	691	Balance Wheel Set Screw.....	03
*5900	—	Bed.....	5 00
3016	679	" Hinge.....	03
3017	—	" " (half butt) for 5900.....	02
3018	—	" " " " Wood Table.....	02
3020	683	" " Pin.....	01
3021	686	" " Rivet..... per 100..	25
5969	697	Crank Connecting Rod.....	80
*4849	—	" " " Cap.....	—
158E	691	" " " Screw.....	03
566c	692	" " " Hinge Screw.....	15
1513	693	" " " " Nut.....	05
5978	696	Driving Flange.....	50
5979	693	" " Latch.....	10
136	691	" " Hinge Screw.....	04
435c	691	" " Set Screw.....	04
5980	683	" " Spring.....	05
330D	692	" " " Screw.....	03
5993	—	" " 5978 with 136, 330D, 5979 and 5980, for Loose Wheel Attachment 5981.....	75
5982	696	Face Plate for 5797 and 5989.....	75
164D	691	" " Screw.....	04
5902	677	Feed Bar.....	40
313c	692	" " Screw Centre.....	04
1519	693	" " " " Nut.....	03
3032	678	" Cam with 446c.....	35
446c	691	" " Set Screw.....	03

No.	Plate	Name	Each
3033	681	Feed Connecting Link.....	20
375c	692	" " " Hinge Screw.....	12
1518	693	" " " " Nut.....	04
5774	689	" Dog (double), 12 teeth.....	1 00
5776	688	" " for sewing buff wheels.....	1 00
5905	690	" " " tent work.....	1 00
5906	690	" " " canvas work.....	1 00
191c	691	" " Screw.....	03
5907	697	" Forked Connection.....	60
375c	692	" " " Hinge Screw.....	12
1518	693	" " " " Nut.....	04
5908	697	" Lifting Rock Shaft.....	45
5909	—	" " " " 5908 with 3166.....	85
3166	682	" " " " Crank with 157E and 1813.....	40
157E	691	Feed Lifting Rock Shaft Crank Clamping Scr.....	04
1813	693	" " " " " Roller and Stud.....	20
304c	692	" " " " Screw Centre.....	06
1513	693	" " " " " Nut.....	05
3039	681	" Regulator.....	25
58E	691	" " Hinge Screw.....	15
818D	692	" " Thumb ".....	12
5910	697	" Rock Shaft.....	55
5911	—	" " " 5910 with 5913.....	75
5913	682	" " " Crank for 5911.....	20
2049	686	" " " Pin.....	01
304c	692	" " " Screw Centre.....	06
1513	693	" " " " Nut.....	05
5981	—	Loose Wheel Attachment complete, Nos. 5977 and 5993.....	2 50
5465	678	Needle Bar.....	40
3045	681	" " Connecting Link.....	30
377c	692	" " " Hinge Screw.....	12
1518	693	" " " " Nut.....	04
2052	683	" " " Stud with 155c.....	30
155c	691	" " " Set Screw.....	03
290E	692	" " Screw Bushing.....	06
4803	686	" Clamp with 651D, 808 and 4802.....	45
808	691	" " Screw.....	03
4802	686	" " Thread Guide for 4803.....	10
651D	692	" " " Screw.....	01
5970	679	Oscillating Rock Shaft (steel) for 1885.....	1 00
3052	678	" " " Hinge Pin.....	50
1513	693	" " " " Nut.....	05
635c	692	" " " " Scr. Bearing.....	10
1513	693	" " " " " Nut.....	05
11165	695	Oscillating Rock Shaft Oil Pad.....	01
5834	697	" Shaft.....	50
5917	682	" " Collar with 455c.....	20
455c	692	" " " Set Screw.....	02

From the library of: Diamond Needle Corp

No.	Plate	Name.	Each.
5966	—	Oscillating Shaft Crank	30
5967	681	" " " 5966 with 1513 and 1885	75
2049	686	" " " Pin	01
1885	693	" " " Roller and Screw Stud.	40
190	691	" " " " " "	
		Cap Screw	08
5968	686	Oscillating Shaft Crank Roller and Screw Stud	
		Cap Screw Washer	02
1513	693	Oscillating Shaft-Crank Roller and Screw Stud	
		Nut	05
8054	678	Presser Bar	35
5990	681	" " Lifter	25
689c	691	" " " Screw	08
1520	693	" " " Nut	08
5608	679	" " Lifting Bracket with 453c	25
453c	692	" " " " Set Screw	02
290E	692	" " Screw Bushing	06
8056	678	" " Spring	05
2070	686	" " Washer	01
5921	689	" Foot (hinged)	2 00
5922	—	" " Bracket	1 00
5923	686	" " " Hinge Pin	01
5924	—	" " Plate	1 00
190D	691	" " Screw	08
262D	692	Pressure Regulating Thumb Screw	25
5733	—	Shuttle, 2½-inch diam., with 5810	5 00
5810	684	" Bobbin (solid and hardened)	25
5784	684	" " Case, includes 591, 592E, 5785, 5789, 5838, 5933 and 5935	2 50
5785	—	Shuttle Bobbin Case Hinge, includes 5786, 5787 and 5788	60
5786	684	Shuttle Bobbin Case Latch	25
5787	684	" " " Lever	25
5788	684	" " " Fulcrum Pin, per 100	25
5838	—	Shuttle Bobbin Case Latch Spring	05
592E	692	" " " Stop Screw	02
5739	684	Shuttle Bobbin Case Position Finger	10
5933	684	" " " Rivet, per 100	25
5934	684	Shuttle Body	2 50
5832	677	" Driver	1 25
2049	686	" " Pin	01
5972	677	" Race, includes 741D, 5938, 5939, 5942, 5973 and two each 219 and 5965	3 50
5938	677	Shuttle Race Back	60
5965	686	" " " Dowel Pin... per 100	10
5939	677	" " " Spring	30
741D	691	" " " Screw	05
5973	—	" " Body	2 00
5942	677	" " Cap	30
219	691	" " " Screw	02

No.	Plate	Name	Each
5943	677	Shuttle Race Frame with 5944	2 50
129E	691	" " " Clamping Screw	04
5944	686	" " " Steady Pin	01
145	691	" " " Screw	04
5945	—	" " " Slide	40
5946	677	" " " 5945 with 5947 and two 240D	50
5947	682	" " " Spring	10
240D	691	" " " " Screw	01
591	692	" " Tension Regulating Screw	02
5935	684	" " Spring	30
1560	693	Tension Regulating Thumb Nut	04
817	693	" Screw Stud	13
448c	691	" " " Set Screw	08
2108	685	" Spring	08
2105	686	" Thread Guard	03
5983	686	" Washer (felt)	01
5984	686	" " (steel)	01
5795	686	" Wheel	40
5797	—	" " complete (wheel), includes 817, 1560, 2103, 5795 and two each 5983 and 5984	65
12296	686	Thread Eyelet (side of arm)	02
2107	686	" Guard	02
233D	691	" " Screw	02
2455	685	" Retainer Disc	02
1562	693	" " Regulating Thumb Nut	04
418D	693	" " Screw Stud	08
10141	685	" " Spring	01
5989	—	" " complete, includes 418D, 1562, 10141 and two 2455	15
13017	678	Thread Take-up Cam (steel) with 446c	1 25
3012	683	" " " Pin	01
446c	691	" " " Set Screw	03
5954	678	" " Lever with 1819	75
76c	691	" " " Hinge Screw	05
1819	693	" " " Roller and Stud	20
5991	686	" " Spring	03
2127	686	" " " Regulator Plate	08
233D	691	" " " " Screw	02
5775	689	Throat Plate for 5774	1 25
5777	688	" " " 5776	1 25
5802	689	" " " Carpet Mitres, for 5774	1 25
5950	690	" " " 5905	1 25
5951	690	" " " 5906	1 25
742	692	" " " Screw	05

## 42-3 MACHINE.

C. B. DROP FEED, BOTH SIDES OF NEEDLE, VIBRATING PRESSER,  
LINK NEEDLE BAR CONNECTION CLOTH.

This Machine is Composed of the SAME PARTS as 42-2 Machine,  
Excepting:

No	Plate.	Name.	Each
* 5819	—	Arm, substituting 4287	6 00
5820	675	Face Plate for 5797 and 5989, substituting 5982	75
5774	689	Feed Dog (double), 12 teeth	1 00
5821	675	Lifting Lever	1 25
5822	676	" " Adjusting Block	50
5823	676	" " " " Roller	12
5824	676	" " " " " Pin	05
266D	676	" " " " Thumb Screw	12
248	676	" " " " " " "	"
		Stop Screw	02
5835	676	Lifting Lever Hinge Bracket	50
180	691	" " " " Screw	03
4810	683	" " " " Stud	10
207D	691	" " " " " Scr	02
3146	686	" " " " " Washer	01
5836	—	" " " " 5835 with 4810	05
5825	—	" " 5821 with 248, 266D, 5822 to 5824	2 00
5826	676	" Cam for 5764	75
902E	—	" " Screw	12
3147	—	Needle Bar Connecting Stud with 155c, substituting 2052	30
		155c 691 Needle Bar Connecting Stud Set Screw	03
5827	675	Presser Bar Lifting Bracket with 453c, substituting 5608	35
5764	680	Thread Take-up Cam (steel) with 446c, substituting 13017	1 50
5828	675	Thread Take-up Lever with 1819, substituting 5954	85
5802	689	Throat Plate	1 25
742	692	" " Screw	05
5829	675	Vibrating Presser	2 00
5837	676	" " Guide Bracket	75
190	691	" " " " Screw	03
5830	676	" " Hinge Bracket with 453c	75
212D	691	" " " " Cap Screw	04
453c	692	" " " " Set " "	02
5831	676	" " Spring	05
233D	691	" " " Screw	02
2269	686	" " Stop Pin	01

## 42-4 MACHINE.

DROP FEED AT LEFT OF NEEDLE, ROLLER PRESSER, LINK  
NEEDLE BAR CONNECTION, CYLINDER SHUTTLE,  
LEATHER.

No.	Plate.	Name.	Each
* 4287	—	Arm	4 50
2002	686	" Dowel Pin	02
4448	695	" Oil Tube for intermediate bearing	06
123E	691	" Screw	06
6109	696	" Shaft for 3011	1 50
6107	696	" " " 5977	1 50
3005	678	" " Bushing (back)	25
448c	691	" " " " Set Screw	03
* 4449	—	" " " (front)	30
144D	691	" " Screw	12
4288	678	" Side Cover	10
286D	692	" " " Thumb Screw	08
5811	695	" Spool Pin and Thread Eyelet	05
3011	696	Balance Wheel (two-speed) for 6109 with two 448c	1 75
5977	696	Balance Wheel (two-speed) for Loose Wheel Attachment 5981	1 75
448c	691	Balance Wheel Set Screw	03
* 5992	—	Bed	5 00
3016	679	" Hinge	03
3017	—	" " (half butt) for 5992	02
3018	—	" " " " wood table	02
3020	683	" " Pin	01
3021	686	" " Rivet	per 100
5969	697	Crank Connecting Rod	80
* 4349	—	" " " Cap	—
158E	691	" " " " Screw	03
506c	692	" " " " Hinge Screw	15
1513	693	" " " " Nut	05
5978	696	Driving Flange	50
5979	683	" " Latch	10
136	691	" " " Hinge Screw	04
435c	691	" " Set Screw	04
5980	683	" " Spring	05
330D	692	" " " Screw	03
5993	—	" " 5978 with 136, 330D, 5979 and 5980, for Loose Wheel Attachment 5981	75
5982	696	Face Plate for 5797 and 5989	75
164D	691	" " Screw	04
5994	679	Feed Bar	30
313c	692	" " Screw Centre	04
1519	693	" " " " Nut	03
3032	678	" Cam with 446c	35
446c	691	" " Set Screw	03

No.	Plate	Name	Each
3038	681	Feed Connecting Link.....	20
375c	692	" " " Hinge Screw.....	12
1518	693	" " " " Nut.....	04
5995	688	" Dog (leather) 8 teeth.....	40
191c	691	" " Screw.....	03
3037	697	" Forked Connection.....	60
375c	692	" " " Hinge Screw.....	12
1518	693	" " " " Nut.....	04
5996	697	" Lifting Rock Shaft.....	50
5997	679	" " " " Crank Fork with 157E	40
157E	691	" " " " Fork Clamp- ing Screw.....	04
5998	679	Feed Lifting Rock Shaft Crank with 1813 and two 172E.....	50
172E	691	Feed Lifting Rock Shaft Crank Clamping Screw for 5998.....	04
1813	693	Feed Lifting Rock Shaft Crank Roller and Stud	20
3039	681	" Regulator.....	25
58E	691	" " " Hinge Screw.....	15
818D	692	" " " Thumb ".....	12
3043	697	Feed Rock Shaft.....	35
3041	—	" " " 3043 with 3043.....	50
3043	682	" " " Crank.....	15
2049	686	" " " " Pin.....	01
804c	692	" " " " Screw Centre.....	06
1513	693	" " " " Nut.....	05
5981	—	Loose Wheel Attachment complete, Nos. 5977 and 5993.....	2 50
5465	678	Needle Bar.....	40
3045	681	" " " Connecting Link.....	30
377c	692	" " " " Hinge Screw.....	12
1518	693	" " " " " Nut.....	04
2052	688	" " " " Stud with 155c.....	30
155c	691	" " " " " Set Screw.....	03
290E	692	" " " " Screw Bushing.....	06
4803	686	" " " " Clamp with 651D, 808 and 4802.....	45
808	691	" " " " Screw.....	03
4802	686	" " " " Thread Guide.....	10
651D	692	" " " " " Screw.....	01
5778	696	Oil Cup.....	55
5779	695	" " " Pad (felt).....	02
211	692	" " " " Screw.....	02
7071	695	" " " " Washer.....	01
135D	691	" " " " " Screw.....	05
5780	695	" " " " Thread Eyelet.....	01
5781	—	" " " " complete, includes Nos. 211, 5778, 5779, 5780 and 7071.....	60
5970	679	Oscillating Rock Shaft (steel) for 1885.....	1 00
3052	678	" " " " Hinge Pin.....	50
1513	693	" " " " " Nut.....	05
635c	692	" " " " " Scr. Bearing	10

No.	Plate	Name	Each
1513	693	Oscillating Rock Shaft Hinge Pin Scr. Bearing	05
		Nut.....	01
11165	695	Oscillating Rock Shaft Oil Pad.....	50
5884	697	" " " Shaft.....	20
5917	682	" " " Collar with 455c.....	02
455c	692	" " " " Set Screw.....	30
5999	—	" " " Crank.....	75
6000	—	" " " " 5999 with 1513 and 1885	01
2049	686	" " " " Pin.....	40
1885	693	" " " " Roller and Screw Stud	03
190	691	" " " " " Cap Screw.....	02
5968	686	Oscillating Shaft Crank Roller and Screw Stud	05
		Cap Screw Washer.....	25
1513	693	Oscillating Shaft Crank Roller and Screw Stud	08
		Nut.....	35
3054	678	Presser Bar.....	25
5990	681	" " " Lifter.....	08
689c	691	" " " " Screw.....	03
1520	693	" " " " " Nut.....	25
5608	679	" " " " Lifting Bracket with 458c.....	02
458c	692	" " " " " Set Screw.....	06
290E	692	" " " " Screw Bushing.....	05
3056	678	" " " " Spring.....	01
2070	686	" " " " Washer.....	75
5971	687	" " " " Foot (long shank).....	03
190D	691	" " " " " Screw.....	25
262D	692	Pressure Regulating Thumb Screw.....	60
5964	687	Roller Presser complete, 1½-in., includes 176, 440, 1549, 1875, 2205, 3223, 6585, and two each 316 and 1547.....	1 30
1875	—	Roller, 1½-in., with 634D and 1528.....	20
6585	—	" " " Arm.....	03
440c	691	" " " " Adjusting Screw.....	03
1547	693	" " " " " Nut.....	20
3223	—	" " " " Bracket.....	03
316c	692	" " " " " Screw Centre.....	03
1547	693	" " " " " Nut.....	04
2205	695	" " " " " Lock Spring.....	08
176	691	" " " " " Screw.....	03
1549	693	" " " " " Nut.....	08
634D	692	" " " " " Screw.....	03
1528	693	" " " " " Nut.....	6 00
5751	685	Shuttle (cylinder), 2½-in. diam., with 14535...	25
14535	685	" " " Bobbin (solid and hardened).....	2 50
12098	685	" " " Cylinder.....	02
12000	685	" " " " Hinge Pin.....	15
12001	685	" " " " Latch.....	01
12002	685	" " " " Pin.....	03
12003	685	" " " " Spring.....	

No.	Plate.	Name.	Each
590E	692	Shuttle Cylinder Latch Spring Screw.....	02
583B	679	" Driver.....	1 25
2049	686	" " Pin.....	01
5752	685	" Frame.....	2 75
5754	677	Shuttle Race, includes 741D, 5755, 5756, 5760, 5988, 5939 and two each 219, 5790 and 5965	3 50
5988	677	Shuttle Race Back.....	60
5965	686	" " Dowel Pin.....per 100..	10
5939	677	" " Spring.....	30
741D	691	" " Screw.....	05
5755	—	" " Body.....	2 00
5760	683	" " Cap (left).....	10
5756	683	" " (right).....	10
5790	686	" " Dowel Pin.....	—
219	691	" " Screw.....	02
5943	677	" " Frame with 5944.....	2 50
129E	691	" " Clamping Screw.....	04
5944	686	" " Steady Pin.....	01
145	691	" " Screw.....	04
5945	—	" " Slide.....	40
5946	677	" " 5945 with 5947 and two 240D	50
5947	682	" " Spring.....	10
240D	691	" " Screw.....	01
773C	692	" Tension Regulating Screw.....	05
12095	685	" " Spring.....	40
1560	693	Tension Regulating Thumb Nut.....	04
817	693	" Screw Stud.....	12
448C	691	" " Set Screw.....	03
2103	685	" Spring.....	03
2105	686	" Thread Guard.....	03
5982	686	" Washer (felt).....	01
5984	686	" " (steel).....	01
5795	686	" Wheel.....	40
5797	—	" complete (wheel), includes 817, 1560, 2103, 5795 and two each 5983 and 5984	65
1296	686	Thread Eyelet (side of arm).....	02
2107	686	" Guard.....	02
283D	691	" " Screw.....	02
2455	685	" Retainer Disc.....	02
1562	693	" " Regulating Thumb Nut.....	04
418D	693	" " Screw Stud.....	03
10141	685	" " Spring.....	01
5989	—	" " complete, includes 418D, 1562, 10141 and two 2455.....	15
5757	678	Thread Take-up Cam (steel) with 446C.....	1 25
3012	683	" " Pin.....	01
446C	691	" " Set Screw.....	03
5758	678	" " Lever with 1819.....	75
76C	691	" " Hinge Screw.....	05
1819	693	" " Roller and Stud.....	20

No.	Plate.	Name.	Each
5991	686	Thread Take-up Spring.....	08
2127	686	" " Regulator Plate.....	03
233D	691	" " " " " Screw..	02
5759	688	Throat Plate.....	1 25
742	692	" " Screw.....	05

## 42-5 MACHINE.

DROP FEED, CYLINDER SHUTTLE, ALTERNATING PRESSERS.

No.	Plate.	Name.	Each
* 5801	—	Arm.....	6 00
2002	696	" Dowel Pin.....	02
4448	695	" Oil Tube for intermediate bearing.....	06
123E	691	" Screw.....	06
6109	696	" Shaft for 8011.....	1 50
6107	696	" " 5977.....	1 50
3005	678	" " Bushing (back).....	25
448C	691	" " " " Set Screw.....	03
* 4449	—	" " (front).....	30
144D	691	" " Screw.....	12
4288	678	" Side Cover.....	10
286D	692	" " " Thumb Screw.....	08
5811	695	" Spool Pin and Thread Eyelet.....	05
3011	696	Balance Wheel (two-speed) for 6109 with two 448C.....	1 75
5977	696	Balance Wheel (two-speed) for Loose Wheel Attachment 5981.....	1 75
448C	691	Balance Wheel Set Screw.....	03
* 5992	—	Bed.....	5 00
3016	679	" Hinge.....	03
3017	—	" " (half butt) for 5992.....	02
3018	—	" " " " " Wood Table.....	02
3020	683	" " Pin.....	01
3021	686	" " Rivet.....per 100..	25
5969	697	Crank Connecting Rod.....	80
* 4849	—	" " " Cap.....	—
158E	691	" " " " Screw.....	08
566C	692	" " " Hinge Screw.....	15
1513	693	" " " " " Nut.....	05
5978	696	Driving Flange.....	50
5979	683	" " Latch.....	10
136	691	" " " Hinge Screw.....	04
485C	691	" " Set Screw.....	04
5980	683	" " Spring.....	05
330D	692	" " " Screw.....	08
5998	—	" " 5978 with 136, 330D, 5979 and 5980, for Loose Wheel Attachment 5981....	75





No.	Plate.	Name.	Each
12093	685	Shuttle Cylinder.....	2 50
12000	685	" " Hinge Pin.....	03
12001	685	" " Latch.....	15
12002	685	" " Pin.....	01
12003	685	" " Spring.....	03
590E	692	" " Screw.....	03
5833	679	" Driver.....	1 25
2049	686	" Pin.....	01
5752	685	" Frame.....	2 75
5754	677	" Race, includes Nos. 741D, 5755, 5756, 5760, 5938, 5939 and two each 219, 5790, and 5965.....	3 50
5988	677	Shuttle Race Back.....	60
5965	686	" " Dowel Pin.....per 100..	10
5989	677	" " Spring.....	30
741D	691	" " Screw.....	05
5755	—	" Body.....	2 00
5760	683	" Cap (left).....	10
5756	683	" " (right).....	10
5790	686	" " Dowel Pin.....	—
219	691	" " Screw.....	03
5943	677	" " Frame with 5944.....	2 50
129E	691	" " Clamping Screw.....	04
5944	686	" " Steady Pin.....	01
145	691	" " Screw.....	04
5945	—	" " Slide.....	40
5946	677	" " 5945 with 5947 and two 240D.....	50
5947	682	" " Spring.....	10
240D	691	" " Screw.....	01
7730	692	" Tension Regulating Screw.....	05
12095	685	" " Spring.....	40
1560	693	Tension Regulating Thumb Nut.....	04
817	693	" " Screw Stud.....	12
4480	691	" " Set Screw.....	03
2103	685	" Spring.....	03
2105	686	" Thread Guard.....	03
5983	686	" Washer (felt).....	01
5984	686	" " (steel).....	01
5795	686	" Wheel.....	40
5797	—	" complete (wheel) includes 817, 1560, 2103, 5795 and two each 5983 and 5984.....	65
12096	686	Thread Eyelet (side of arm).....	02
2108	—	" Guard.....	01
233D	691	" " Screw.....	02
2455	685	" Retainer Disc.....	03
1562	693	" " Regulating Thumb Nut.....	04
418D	693	" " Screw Stud.....	08
10141	685	" " Spring.....	01
5989	—	" complete, includes 418D, 1562, 10141 and two 2455.....	15

No	Plate.	Name	Each
5793	680	Thread Take-up Cam (steel) with 4460.....	1 50
3012	683	" " Pin.....	01
4460	691	" " Set Screw.....	03
5758	678	" " Lever with 1819.....	75
760	691	" " Hinge Screw.....	05
1819	693	" " Roller and Stud.....	20
5991	686	" " Spring.....	03
2127	686	" " Regulator Plate.....	03
233D	691	" " Screw.....	02
5759	688	Throat Plate for 5995.....	1 25
742	692	" " Screw.....	05
3134	680	Vibrating Presser Bar.....	45
2361	683	" " Hinge Bracket.....	50
2362	—	" " Rivet.....	01
602D	691	" " Cap Screw.....	02
3135	680	" " Lifting Bell Crank....	75
602D	691	" " " " " " " "	—
		Hinge Cap Screw.....	02
5794	683	Vibrating Presser Foot.....	60
217	691	" " Screw.....	03
3137	682	" " Spring.....	10
337E	692	" " Screw.....	02

## No. 42-8 MACHINE.

C B. DROP FEED ALTERNATING PRESSERS.

This Machine is Composed of the Same Parts as 42-5 Machine, Excepting:

No.	Plate.	Name.	Each
*5801	—	Arm, substituting 4375.....	6 00
5902	677	Feed Bar, substituting 5994.....	40
5812	694	" Dog (double), substituting 5995.....	1 00
5815	697	" Lifting Rock Shaft, substituting 5996....	50
3166	682	" " Crank with 157E and 1813, substituting 5998.....	40
5816	694	Lifting Presser Foot, substituting 5792.....	40
217	691	" " Screw, substituting 193.....	03
5966	—	Oscillating Shaft Crank, substituting 5999....	30
5967	681	" " 5966 with 1513 and 1885, substituting 6000.....	75
5783	—	Shuttle, 2½-in. diam. with 5810, substituting 5751.....	5 00
5810	684	Shuttle Bobbin (solid and hardened), substi- tuting 14535.....	25
5784	684	Shuttle Bobbin Case includes Nos 591, 592E, 5785, 5789, 5888, 5933 and 5935.....	2 50
5785	—	Shuttle Bobbin Case Hinge, includes 5786, 5787 and 5788.....	60

No.	Plate	Name	Each
5786	684	Shuttle Bobbin Case Latch.....	25
5787	684	" " " " Lever.....	25
5788	684	" " " " " Fulerum Pin per 100.....	25
5838	—	Shuttle Bobbin Case Latch Spring.....	05
592e	692	" " " " Stop Screw.....	02
5789	684	" " " " Position Finger.....	10
5933	684	" " " " " Rivet per 100.....	25
5934	684	Shuttle Body.....	2 50
5832	677	" Driver, substituting 5833.....	1 25
5972	677	" Race, includes 741b, 5938, 5939, 5942, 5973 and two each 219 and 5965, substituting 5754.....	3 50
5973	—	Shuttle Race Body, substituting 5755.....	2 00
5942	677	" Cap, substituting 5760 and 5756	30
591	692	" Tension Regulating Screw, substituting 773.....	02
5935	684	Shuttle Tension Spring, substituting 12095...	30
5817	680	Thread Take-up Cam (steel) with 446c, substituting 5793.....	1 50
5954	678	Thread Take-up Lever with 1819, substituting 5758.....	75
5813	694	Throat Plate for 5812, substituting 5759.....	1 25
5814	694	Vibrating Presser Foot, substituting 5794....	75

### ACCESSORIES.

No.	Plate	Name	Each
5975	698	Drip Pan (Stand), with four wood screws, $\frac{1}{2}$ -in., No. 5.....	30
5976	—	Drip Pan (Power Table), with four wood screws, $\frac{1}{2}$ -in., No. 5.....	30
25867	—	Guide (cloth). Old No. 559, A. & A.....	10
25868	—	" " for carpet mitres. Old No. 560, A. & A.....	40
747b	—	Guide Thumb Screw.....	10
25952	—	Oiler with Cap and Spout. Old No. 325, A. & A.	05
25953	—	" 25952 filled with oil. " " 326, "	08
25954	—	" Spout. " " 327, "	01
26026	—	Screw Driver (Machine). " " 393, "	10
26027	—	" " (Shuttle Tension), with wood handle. Old No. 395, A. & A.....	05
4822	—	Wrench for 1547, 1548 and 1549. Old No. 375, A. & A.....	05
4847	—	Wrench for 1513 and 1518.....	15

### BOBBIN WINDERS.

#### BOBBIN WINDER FOR 42-2, 42-3 AND 42-8 MACHINES.

No.	Plate	Name	Each
5958	680	Bracket.....	20
159	691	" Screw.....	08
5959	680	Frame.....	15
46b	691	" Hinge Screw.....	06
5960	678	Friction Wheel (leather).....	10
5961	678	" " Washer.....	05
333b	692	" " " Screw.....	04
5962	678	Spindle.....	15
5963	678	" Flange.....	06
5957	—	Frame complete, includes 333b and 5959 to 5963.....	60
11114	682	Spring.....	08
190	691	" Screw.....	03
5974	680	Bobbin Winder complete, includes 46b, 190, 5957, 5958 and 11114.....	90

#### BOBBIN WINDER FOR 42-4 AND 42-5 MACHINES.

No.	Plate	Name	Each
5958	680	Bracket.....	20
159	691	" Screw.....	08
5959	680	Frame.....	15
46b	691	" Hinge Screw.....	06
5960	678	Friction Wheel (leather).....	10
5961	678	" " Washer.....	05
333b	692	" " " Screw.....	04
5761	678	Spindle.....	20
5963	678	" Flange.....	06
5809	—	Frame complete, includes 333b, 5761, 5959 to 5961 and 5963.....	65
11114	682	Spring.....	08
190	691	" Screw.....	08
5762	680	Bobbin Winder complete, includes 46b, 190, 5809, 5958 and 11114.....	95

### KNEE LIFTER PARTS.

#### (POWER TABLE).

No.	Plate	Name	Each
5596	—	Bell Crank.....	05
5599	—	" " Bracket.....	08
178	691	" " " Screw.....	08
5601	—	" " Hinge Pin.....	01

No.	Plate	Name	Each
5602	—	Bell Crank Spring.....	02
5598	690	" " 5596 with 5599, 5601 and 5602 . . . .	20
5607	697	Lifting Lever for 42-2, 42 3 and 42-4 Machs..	20
4724	697	" " " 42-5 and 42-8 Machines....	25
4728	679	" " Connecting Rod for 42-5 and 42-8 Machines.....	08
12416	681	Lifting Lever Connecting Rod Joint for 42-5 and 42-8 Machines.....	08
76D	691	Lifting Lever Connecting Rod Joint Hinge Screw for 42-5 and 42-8 Machines.....	05
1521	693	Lifting Lever Connecting Rod Joint Lock Nut for 42-5 and 42-8 Machines.....	03
802D	691	Lifting Lever Hinge Screw.....	12
4725	695	" " Lifting Bracket for 42-5 and 42-8 Machines.....	50
4726	695	Lifting Lever Lifting Bracket Guide Pin for 42-5 and 42-8 Machines.....	03
4727	695	Lifting Lever Pin for 4724 for 42-5 and 42-8 Machines.....	05
448C	691	Lifting Lever Pin Set Screw for 42-5 and 42-8 Machines.....	03
5614	679	Pitman for 42-2, 42-3 and 42-4 Machines.....	03
2768	697	Rock Shaft.....	10
12242	697	" " Hanger, with two wood screws, 1½-in., No. 10.....	08
2765	697	Rock Shaft Knee Arm.....	10
2766	697	" " " " Hub with 356C.....	15
356C	693	" " " " " Set Screw.....	06
2768	—	" " " " 2765 with 2766 and 2767	40
2767	697	" " " " Plate with 356C.....	18
356C	693	" " " " " Set Screw.....	06
6937	697	" " Lifting Bracket with two 356C....	20
2778	697	" " " " Hook.....	05
356C	693	" " " " " Set Screw... ..	06
356C	693	" " " " " Set Screw.....	06
2770	697	" " Stop Dog with 356C.....	12
356C	693	" " " " " Set Screw .....	06
2777	697	" " 2763 with 2769, 2770, 2778, 6937 and two 12242.....	1 00
5587	—	Knee Lifter complete, includes 802D, 2777, 5598, 5607, 5614 and two 178 for 42-2, 42-3 42-4 Machines.....	2 00
4816	—	Knee Lifter complete, includes 76D, 802D, 1521, 2777, 4724 to 4728, 5598, 12416, two 178 and four wood screws, 1½-in., No. 10, for 42-5 and 42-8 Machines.....	2 25

### KNEE LIFTER PARTS. (STAND).

No.	Plate.	Name.	Each
5596	—	Bell Crank.....	05
5599	—	" " Bracket.....	08
178	691	" " " Screw.....	08
5601	—	" " Hinge Pin.....	01
5602	—	" " Spring.....	02
5598	690	" " 5596 with 5599, 5601 and 5602.....	20
5607	697	Lifting Lever for 42-2, 42-3 and 42-4 Machs..	20
4724	697	" " " 42-5 and 42-8 Machines....	25
4728	679	" " Connecting Rod for 42-5 and 42-8 Machines.....	08
12416	681	Lifting Lever Connecting Rod Joint for 42-5 and 42-8 Machines.....	08
76D	691	Lifting Lever Connecting Rod Joint Hinge Screw for 42-5 and 42-8 Machines.....	05
1521	693	Lifting Lever Connecting Rod Joint Lock Nut for 42-5 and 42-8 Machines.....	03
802D	691	Lifting Lever Hinge Screw.....	12
4725	695	" " Lifting Bracket for 42-5 and 42-8 Machines.....	50
4726	695	Lifting Lever Lifting Bracket Guide Pin for 42-5 and 42-8 Machines.....	03
4727	695	Lifting Lever Pin for 4724.....	05
448C	691	" " " Set Screw.....	03
5614	679	Pitman for 42-2, 42-3 and 42-4 Machines.....	03
5772	697	Rock Shaft.....	12
7539	697	" " Hanger, with two wood screws, 1-in., No. 10.....	08
2765	697	Rock Shaft Knee Arm.....	10
2766	697	" " " " Hub with 356C.....	15
356C	693	" " " " " Set Screw.....	06
2768	—	" " " " 2765 with 2766 and 2767	40
2767	697	" " " " Plate with 356C.....	18
356C	693	" " " " " Set Screw .....	06
6937	697	" " Lifting Bracket with two 356C....	20
12243	697	" " " " Hook.....	15
356C	693	" " " " " Set Screw... ..	06
356C	693	" " " " " Set Screw.....	06
2770	697	" " Stop Dog with 356C.....	12
356C	693	" " " " " Set Screw.....	06
5773	—	" " 5772 with 2768, 2770, 6937, 12243 and two 7539.....	1 10
5805	—	Knee Lifter complete, includes 802D, 5598, 5607, 5614, 5773 and two 178, for 42-2, 42-3 and 42-4 Machines.....	1 75
5818	—	Knee Lifter complete, includes 76D, 802D, 1521, 4724 to 4728, 5598, 5773, 12416, two 178C and four wood screws, 1-in., No. 10, for 42-5 and 42-8 Machines.....	2 85

## STAND PARTS.

No.	Plate.	Name.	Each
25001	698	Back Leaf Bracket.....	10
25002	698	" " Scroll Bracket.....	15
25003	698	" " Sliding Hinge.....	25
25151	698	" " " Plate for 25003.....	05
25138	698	Band Wheel (two speed), 10 and 12 inches diam., with 25010.....	8 00
25010	698	Band Wheel Crank.....	15
2117	695	" " " Pin.....	01
2970	692	" " " Screw Centre.....	10
1507	693	" " " " Nut.....	04
25136	—	Belt, size $\frac{5}{8}$ -in., length 62 $\frac{1}{2}$ -in., with 25029...	30
25029	695	" Hook.....	01
25166	698	Brace with three each 2970 and 1507.....	1 70
5062	692	" Bolt with 1510.....	03
1510	693	" " Nut.....	01
25057	698	End Leaf Support.....	25
25168	680	" " " Bracket.....	10
25060	698	" " " Button.....	08
25169	—	" " " Lever.....	15
25143	695	" " " " Hinge Pin.....	01
25064	698	Leg.....	1 60
25070	695	Machine Cushion Tack (rubber).....	01
25074	698	Pitman (adjustable).....	25
25123	—	" Adjusting Block.....	02
5582	698	" " " Screw.....	08
1570	693	" " " Nut.....	01
25075	695	" " " Washer.....	01
7958	695	" Stud Pin.....	01
11742	695	" Washer.....	01
25082	698	Treadle.....	65
2970	692	" " " Screw Centre.....	10
1507	693	" " " Nut.....	04
25086	698	Wrench for 1507 and 1510.....	10
25226	—	Stand complete, with 25136 (Table not included).....	9 38

## OBSOLETE PARTS.

No.	Plate.	Name.	Each
*13019	—	Arm, for 42-2 and 42-4 Machines, use 4287...	4 50
*4381	—	" " 42-3 Machine, use 5819.....	6 00
2007	688	" Spool Pin use 5811.....	02
5783	696	Face Plate for 5797 and 5989 for 42-3 Mach...	75
5903	—	Feed Dog for canvas work (double), distance between rows $\frac{1}{2}$ -in. for 42-2 Machine.....	1 00

No.	Plate	Name	Each
3132	—	Guide Bar Lifting Bracket with 6260 for 42-5 Machine.....	1 50
4807	679	Lifting Lever for 42-3 Machine.....	75
4808	679	" " Adjusting Block for 42-3 Mach.....	16
5806	686	" " " " Hinge Pin for 42-3 Machine.....	01
574	692	Lifting Lever Adjusting Block Thumb Screw for 42-3 Machine.....	15
1528	693	Lifting Lever Adjusting Block Thumb Screw Nut for 574.....	08
4809	688	Lifting Lever Hinge Bracket for 42-3 Mach...	40
4811	—	" " " " 4809 with 4810 for 42-3 Machine.....	55
4812	—	Lifting Lever 4807 with 574, 1528, 4808, and 5806 for 42-3 Machine.....	1 10
1806	693	Lifting Roller and Screw for 5764 for 42-3 Machine.....	30
5607	697	Lifting Lever (Knee Lifter) for 42-5 Machine.....	20
5682	686	Needle Clamp with 246 and 5691, for 42-2, 42-3 and 42-4 Machines, use 4803.....	45
5691	686	Needle Clamp Thread Guide for 5682.....	10
5915	—	Oscillating Shaft for 5936.....	50
5914	677	" Rock Shaft for 1878.....	1 00
5919	682	" Shaft Crank with 1878 and 1520...	65
1878	—	" " " Roller and Screw Stud	35
1520	693	" " " " " " " " " " Nut.....	08
20620	681	Presser Bar Lifter for 42-3 and 42-4 Machines, use 5990.....	25
5610	680	Presser Bar Lifting Bracket for 42-5 Machine.....	25
5926	—	Shuttle, 2 $\frac{1}{2}$ -in. diam., with 5927, for 42-2, 42-3 and 42-8 Machines, use 5783.....	5 00
5927	684	Shuttle Bobbin for 5926, use 5810.....	25
5929	684	" " Case, includes 591, 5922, 5930 to 5932, 5935 and two 5933 for 5926, use 5784	2 50
5930	684	Shuttle Bobbin Case Latch for 5929.....	25
5931	684	" " " " Spring for 5929...	05
5932	684	" " " Position Finger for 5929.....	10
5936	—	" Driver for 42-2, 42-3 and 42-8 Machs...	1 25
5753	—	" " " 42-4 and 42-5 Machines....	1 25
5937	—	" Race complete, includes 741D, 5938 to 5942 and two each 219, 399 and 5965 for 42-2, 42-3 and 42-8 Machines, use 5972....	3 50
5940	—	Shuttle Race Body for 5937.....	2 00
5941	677	" " Bridge for 5937.....	—
899	—	" " " Screw for 5937.....	02
2102	685	Tension Disc.....	05
600	—	" Screw Stud.....	10
5985	—	" Wheel, use 5795.....	—
*5986	—	" Flange.....	—
5987	—	" Hub.....	—

No.	Plate.	Name.	Each
5988	---	Tension complete (wheel) includes 817, 1560, 2103, 5985 and two each 5988 and 5984, use 5797.....	—
5769	686	Thread Eyelet (side of arm).....	08
5799	686	“ Guard for 5768.....	01
2112	---	Retainer Disc.....	05
2113	---	“ “ “ Steady Pin... per 100 .	10
2114	---	“ “ “ Spring.....	01
2115	---	“ “ “ Stud.....	07
460c	---	“ “ “ Set Screw.....	02
2111	---	“ Retainer complete, includes 2112 to 2115.....	15
5765	---	Thread Take-up Lever with 1819 for 42-3 Machine.....	75
2124	686	Thread Take-up Spring, use 5991.....	08
5948	---	Throat Plate for 5903, for 42-2 Machine.....	1 25
5766	679	Vibrating Presser for 42-3 Machine.....	2 00
5767	---	“ “ Guide Bracket for 42-3 Machine.....	75
5768	683	Vibrating Presser Hinge Bracket for 42-3 Mach.	60
5798	682	“ “ Spring for 42-3 Machine....	05

## Numerical List of Parts.

No.	Plate.	Name.	Each
46D	691	Bobbin Winder Frame Hinge Screw.....	06
58E	691	Feed Regulator Hinge Screw.....	15
76C	691	Thread Take-up Lever Hinge Screw.....	05
76D	691	Lifting Lever Connecting Rod Joint Hinge Screw (Knee Lifter) for 42-5 and 42-8 Machines.....	05
123E	691	Arm Screw.....	06
129E	691	Shuttle Race Frame Clamping Screw.....	04
135D	691	Oil Cup Screw for 42-4, 42-5 and 42-8 Machs..	05
136	691	Driving Flange Latch Hinge Screw.....	04
144D	691	Arm Shaft Screw.....	12
145	691	Shuttle Race Screw.....	04
155C	691	Needle Bar Connecting Stud Set Screw.....	08
157E	691	Feed Lifting Rock Shaft Crank Clamping Scr. for 42-2, 42-3 and 42-8 Machines.....	04
157E	691	Feed Lifting Rock Shaft Crank Fork Clamping Screw for 42-4 and 42-5 Machines....	04
158E	691	Crank Connecting Rod Cap Screw.....	08
159	691	Bobbin Winder Bracket Screw.....	08
164D	691	Face Plate Screw for 42-2, 42-3 and 42-4 Machs.	04
172E	691	Feed Lifting Rock Shaft Crank Clamping Scr. for 5998, for 42-4 and 42-5 Machines.....	04
175	691	Face Plate Screw for 5791.....	02
176	691	Roller Arm Lock Spring Screw for 5964.....	08
178	691	Bell Crank Bracket Screw (Knee Lifter).....	08
180	691	Lifting Lever Hinge Bracket Screw for 42-3 Machine.....	08
190	691	Oscillating Shaft Crank Roller and Screw Stud Cap Screw.....	08
190D	691	Presser Foot Screw.....	08
190	691	Bobbin Winder Spring Screw.....	08
190	691	Vibrating Presser Guide Bracket Screw for 42-3 Machine.....	08
191C	691	Feed Dog Screw.....	08
193	691	Lifting Presser Foot Screw for 5792.....	08
196	676	Needle Clamp Screw for 4265.....	02
207D	691	Lifting Lever Hinge Bracket Stud Screw for 42-3 Machine.....	02
211	692	Oil Cup Pad Screw for 5781.....	02
212D	691	Vibrating Presser Hinge Bracket Cap Screw for 42-3 Machine.....	04
217	691	Vibrating Presser Foot Scr. for 5794 and 5814.	08
217	691	Lifting “ “ “ “ 42-8 Machine.	08
219	691	Shuttle Race Cap Screw.....	02
233D	691	Thread Guard Screw.....	02
233D	691	“ Take-up Spring Regulator Plate Scr..	02
233D	691	Vibrating Presser Spring Screw for 42-3 Mach	02



No.	Plate	Name	Each
240D	691	Shuttle Race Slide Spring Screw.....	01
248	676	Lifting Lever Adjusting Block Thumb Screw Stop Screw for 42-3 Machine.....	02
262D	692	Pressure Regulating Thumb Screw.....	25
266D	676	Lifting Lever Adjusting Block Thumb Screw for 42-3 Machine.....	12
286D	692	Arm Side Cover Thumb Screw.....	08
290E	692	Needle Bar Screw Bushing for 42-2, 42-3 and 42-4 Machines.....	06
290E	692	Presser Bar Screw Bushing for 42-2, 42-3 and 42-4 Machines.....	06
297C	692	Band Wheel Screw Centre (Stand).....	10
297C	692	Treadle Screw Centre (Stand).....	10
304C	692	Feed Lifting Rock Shaft Screw Centre for 42-2 and 42-3 Machines.....	06
304C	692	Feed Rock Shaft Screw Centre.....	06
313C	692	" Bar Screw Centre.....	04
316C	692	Roller Arm Bracket Screw Centre for 5964...	03
330D	692	Driving Flange Spring Screw.....	03
333D	692	Bobbin Winder Friction Wheel Washer Screw	04
337E	692	Vibrating Presser Spring Screw for 42-5 and 42-8 Machines.....	02
356C	693	Rock Shaft Knee Arm Hub Set Screw (Knee Lifter).....	06
356C	693	Rock Shaft Knee Plate Set Screw (Knee Lifter)	06
356C	693	" " Lifting Bracket Hook Set Screw (Knee Lifter).....	06
356C	693	Rock Shaft Lifting Bracket Set Screw.....	06
356C	693	Rock Shaft Stop Dog Set Screw (Knee Lifter)	06
375C	692	Feed Connecting Link Hinge Screw.....	12
375C	692	" Forked Connection Hinge Screw.....	12
377C	692	Needle Bar Connecting Link Hinge Screw for 42-2, 42-3 and 42-4 Machines.....	12
390C	692	Needle Bar Connecting Link Adjusting Screw for 3098.....	02
399	—	Shuttle Race Bridge Screw for 5987, obsolete..	02
404D	692	Guide Bar Lifting Bracket Screw for 42-5 and 42-8 Machines.....	02
418D	693	Thread Retainer Screw Stud.....	08
435C	691	Driving Flange Set Screw.....	04
440C	691	Roller Arm Adjusting Screw for 5964.....	03
446C	691	Feed Cam Set Screw.....	08
446C	691	Thread Take-up Cam Set Screw.....	03
448C	691	Arm Shaft Bushing (back) Set Screw.....	03
448C	691	Balance Wheel Set Screw.....	08
448C	691	Tension Screw Stud Set Screw.....	03
448C	691	Lifting Lever Pin Set Screw for 4724.....	08
453C	692	Presser Bar Lifting Bracket Set Screw for 42-2, 42-3 and 42-4 Machines.....	02

No.	Plate	Name	Each
453C	692	Vibrating Presser Hinge Bracket Set Screw for 42-3 Machine.....	02
455C	692	Oscillating Shaft Collar Set Screw.....	02
460C	—	Thread Retaining Stud Set Screw, obsolete...	02
506E	692	Brace Bolt with 1510 (Stand).....	03
558E	693	Fitman Adjusting Screw (Stand).....	03
566C	692	Crank Connecting Rod Hinge Screw.....	15
574	692	Lifting Lever Adjusting Block Thumb Screw, obsolete, for 42-3 Machine.....	15
590E	692	Shuttle Cylinder Latch Spring Screw for 5751	02
591	692	Shuttle Tension Regulating Screw for 5784...	02
592E	692	" Bobbin Case Latch Stop Screw for 5784	02
598C	691	Presser Bar Lifter Screw for 42-5 and 42-8 Machines.....	06
600	—	Tension Screw Stud, obsolete.....	10
602D	691	Vibrating Presser Bar Hinge Cap Screw for 42-5 and 42-8 Machines.....	02
602D	691	Vibrating Presser Bar Lifting Bell Crank Hinge Cap Screw for 42-5 and 42-8 Machines.....	02
626C	693	Guide Bar Lifting Bracket Guide Screw Stud for 42-5 and 42-8 Machines.....	10
634D	692	Roller Screw for 1875.....	08
635C	692	Oscillating Rock Shaft Hinge Pin Scr. Bearing	10
641E	691	Lifting Presser Bar Bracket Clamp Screw for 42-5 and 42-8 Machines.....	03
651D	692	Needle Clamp Thread Guide Screw.....	01
689C	691	Presser Bar Lifter Screw for 42-2, 42-3 and 42-4 Machines.....	08
690C	691	Guide Bar Driving Crank Wedge Adjusting Screw for 42-5 and 42-8 Machines.....	05
741D	691	Shuttle Race Back Spring Screw.....	05
742	692	Throat Plate Screw.....	05
747	—	Guide Thumb Screw.....	10
773C	692	Shuttle Tension Regulating Screw for 5751....	05
802D	691	Lifting Lever Hinge Screw (Knee Lifter)....	12
808	691	Needle Clamp Screw for 5682 and 4803.....	03
817	693	Tension Screw Stud.....	12
818D	692	Feed Regulator Thumb Screw.....	12
902E	—	Lifting Cam Screw for 42-3 Machine.....	12
1507	693	Band Wheel Screw Centre Nut (Stand).....	04
1507	693	Treadle Screw Centre Nut (Stand).....	04
1510	693	Brace Bolt Nut (Stand).....	01
1513	693	Crank Connecting Rod Hinge Screw Nut....	05
1513	693	Feed Lifting Rock Shaft Screw Centre Nut for 42-2 and 42-3 Machines.....	05
1513	693	Feed Rock Shaft Screw Centre Nut.....	05
1513	693	Oscillating Rock Shaft Hinge Pin Nut.....	05
1513	693	" " " " Screw Bear- ing Nut.....	05
1513	693	Oscillating Shaft Crank Roller and Screw Stud Nut.....	05

No.	Plate	Name	Each
1518	693	Feed Connecting Link Hinge Screw Nut.....	04
1518	693	" Forked Connection Hinge Screw Nut...	04
1518	693	Needle Bar Connecting Link Hinge Screw Nut for 42-2, 42-3 and 42-4 Machines.....	04
1519	693	Feed Bar Screw Centre Nut.....	03
1520	693	Presser Bar Lifter Screw Nut for 42-2, 42-3 and 42-4 Machines.....	03
1520	693	Oscillating Shaft Crank Roller and Screw Stud Nut, obsolete.....	03
1521	693	Lifting Lever Connecting Rod Joint Lock Nut (Knee Lifter) for 42-5 and 42-8 Machines..	03
1528	693	Roller Screw Nut for 634D.....	03
1528	693	Lifting Lever Adjusting Block Thumb Screw Nut for 574, obsolete.....	03
1547	693	Roller Arm Adjusting Screw Nut for 5964....	03
1547	693	" " Bracket Screw Centre Nut for 5964	03
1549	693	" " Lock Spring Screw Nut for 5964.	03
1560	693	Tension Regulating Thumb Nut.....	04
1562	693	Thread Retainer Regulating Thumb Nut....	04
1570	693	Pitman Adjusting Screw Nut (Stand).....	01
1806	693	Lifting Roller and Screw for 5764, obsolete..	30
1813	693	Feed Lifting Rock Shaft Crank Roller and Stud.....	20
1819	693	Thread Take-up Lever Roller and Stud.....	20
1823	693	Lifting Presser Bar Bracket Roller and Stud for 42-5 and 42-8 Machines.....	18
1862	—	Guide Bar Driving Crank Roller for 42-5 and 42-8 Machines.....	13
1875	—	Roller, 1½-in., with 634D and 1523.....	60
1878	—	Oscillating Shaft Crank Roller and Screw Stud, obsolete.....	35
1885	693	Oscillating Shaft Crank Roller and Scr. Stud.	40
2002	686	Arm Dowel Pin.....	02
2007	683	" Spool Pin, obsolete, use 5811.....	02
2049	686	Feed Rock Shaft Crank Pin.....	01
2049	686	Oscillating " " ".....	01
2049	686	Shuttle Driver Pin.....	01
2052	683	Needle Bar Connecting Stud with 155c for 42-2 and 42-4 Machines.....	30
2062c	681	Presser Bar Lifter, obsolete, for 42-2 and 42-4 Machines, use 5990.....	25
2070	686	Presser Bar Spring Washer.....	01
2102	685	Tension Disc, obsolete.....	05
2103	685	" Spring.....	03
2105	686	" Thread Guard.....	03
2107	686	Thread Guard for 42-2, 42-3 and 42-4 Machs...	02
2108	—	" " " 42-5 and 42-8 Machines....	01
2111	—	" Retainer complete, includes 2112 to 2115, obsolete.....	15
2112	—	Thread Retainer Disc, obsolete.....	05

No.	Plate	Name	Each
2113	—	Thread Retainer Disc Steady Pin, obsolete, per 100.....	10
2114	—	Thread Retainer Spring, obsolete.....	01
2115	—	" " Stud ".....	07
2117	695	Band Wheel Crank Pin (Stand).....	01
2124	686	Thread Take-up Spring, obsolete, use 5991..	03
2127	686	" " " Regulator Plate.....	03
2205	695	Roller Arm Lock Spring for 5964.....	04
2269	686	Vibrating Presser Stop Pin for 42-3 Machine.	01
2305	695	Needle Bar Connecting Stud with 155c, for 42-5 and 42-8 Machines.....	30
2359c	695	Presser Bar Lifter for 42-5 and 42-8 Machines.	25
2361	683	Vibrating Presser Bar Hinge Bracket for 42-5 and 42-8 Machines.....	50
2362	—	Vibrating Presser Bar Hinge Bracket Rivet for 42-5 and 42-8 Machines.....	01
2455	685	Thread Retainer Disc.....	02
2763	697	Rock Shaft (Knee Lifter, Power Table).....	10
2765	697	" " Knee Arm (Knee Lifter).....	10
2766	697	" " " Hub with 356c (Knee Lifter).....	15
2767	697	Rock Shaft Knee Plate with 356c (Knee Lifter)	13
2768	—	" " " Arm 2765, with 2766 and 2767 (Knee Lifter).....	40
2770	697	Rock Shaft Stop Dog with 356c (Knee Lifter)	12
2777	697	" " 2763 with 2768, 2770, 2778, 6337 and two 12242 (Knee Lifter, Power Table).	1 00
2778	697	Rock Shaft Lifting Bracket Hook (Knee Lifter, Power Table).....	05
3005	678	Arm Shaft Bushing (back).....	25
3011	696	Balance Wheel (two-speed) for 6109 with two 448c.....	1 75
3012	683	Thread Take-up Cam Pin.....	01
3016	679	Bed Hinge.....	03
3017	—	" " (half butt) for 5900 and 5992.....	02
3018	—	" " " " Wood Table.....	02
3020	683	" " Pin.....	01
3021	686	" " Rivet.....per 100..	25
3032	678	Feed Cam with 446c.....	35
3033	681	" Connecting Link.....	20
3037	697	" Forked Connection for 42-4, 42-5 and 42-8 Machines.....	60
3039	681	Feed Regulator.....	25
3041	—	" Rock Shaft 3042 with 3043 for 42-4, 42-5 and 42-8 Machines.....	50
3042	697	Feed Rock Shaft for 42-4, 42-5 and 42-8 Machs.	35
3043	682	" " " Crank for 42-4, 42-5 and 42-8 Machines.....	15
3045	681	Needle Bar Connecting Link for 42-2, 42-3 and 42-4 Machines.....	30
3052	678	Oscillating Rock Shaft Hinge Pin.....	50



No.	Plate.	Name.	Each
3054	678	Presser Bar for 42-2, 42-3 and 42-4 Machines..	35
3054	678	Lifting Presser Bar for 42-5 and 42-8 Machines	35
3056	678	Presser Bar Spring for 42-2, 42-3 and 42-4 Machines.....	05
3094	686	Guide Bar Driving Crank Wedge for 42-5 and 42-8 Machines.....	10
3098	682	Needle Bar Connecting Link with 390c, for 42-5 and 42-8 Machines.....	75
3100	679	Presser Bar Spring for 42-5 and 42-8 Machs..	05
3126	680	Guide Bar for 42-5 and 42-8 Machines.....	1 50
3130	682	" " Driving Crank with 1862 and 3131, for 42-5 and 42-8 Machines.....	75
3131	—	Guide Bar Driving Crank Roller Cap for 42-5 and 42-8 Machines.....	05
3132	—	Guide Bar Lifting Bracket with 626c, for 42-5 Machine, obsolete.....	1 50
3133	680	Lifting Presser Bar Bracket with 641x and 1823 for 42-5 and 42-8 Machines.....	35
3134	680	Vibrating Presser Bar for 42-5 and 42-8 Machs	45
3135	680	" " Lifting Bell Crank for 42-5 and 42-8 Machines.....	75
3137	682	Vibrating Presser Spring for 42-5 and 42-8 Machines.....	10
3146	686	Lifting Lever Hinge Bracket Stud Scr. Washer for 42-3 Machine.....	01
3147	—	Needle Bar Connecting Stud with 155c, for 42-3 Machine.....	30
3166	682	Feed Lifting Rock Shaft Crank with 157x and 1813, for 42-2, 42-3 and 42-8 Machines.....	40
3228	—	Roller Arm Bracket for 5964.....	20
4264	680	Needle Bar for 42-5 and 42-8 Machines.....	40
4265	686	" Clamp with 196, for 42-5 and 42-8 Machines.....	25
4266	686	Needle Clamp Thread Guide for 42-5 and 42-8 Machines.....	10
* 4287	—	Arm for 42-2 and 42-4 Machines.....	4 50
4288	678	" Side Cover.....	10
4347	—	Wrench for 1513 and 1518.....	15
* 4349	—	Crank Connecting Rod Cap.....	—
4381	—	Arm for 42-3 Machine, obsolete, use 5819.....	6 00
4448	695	" Oil Tube for intermediate bearing.....	06
* 4449	—	" Shaft Bushing (front).....	30
4723	683	Guide Bar Lifting Bracket with 626c for 42-5 and 42-8 Machines.....	1 25
4724	697	Lifting Lever (Knee Lifter) for 42-5 and 42-8 Machines.....	25
4725	695	Lifting Lever Lifting Bracket (Knee Lifter) for 42-5 and 42-8 Machines.....	50
4726	695	Lifting Lever Lifting Bracket Guide Pin (Knee Lifter) for 42-5 and 42-8 Machines.....	08

No.	Plate	Name	Each
4727	695	Lifting Lever Pin for 4724.....	05
4728	679	" " Connecting Rod (Knee Lifter) for 42-5 and 42-8 Machines.....	08
4730	—	Guide Bar 3126 with 337, 2361, 3134, 3135, 3137, 4723 and two each 602d, 2363, and three 404d, for 42-5 and 42-8 Machines.....	5 00
4802	686	Needle Clamp Thread Guide for 4803.....	10
4803	686	" " with 651d, 808 and 4802 for 42-2, 42-3 and 42-4 Machines.....	45
4807	679	Lifting Lever, obsolete, for 42-3 Machine....	75
4808	679	" " Adjusting Block, obsolete, for 42-3 Machine.....	16
4809	683	Lifting Lever Hinge Bracket, obsolete, for 42-3 Machine.....	40
4810	683	Lifting Lever Hinge Bracket Stud for 5835 and 4809.....	10
4811	—	Lifting Lever Hinge Bracket 4809 with 4810, obsolete, for 42-3 Machine.....	35
4812	—	Lifting Lever 4807 with 574, 1528, 4808 and 5806, obsolete, for 42-3 Machine.....	1 10
4816	—	Knee Lifter complete (Power Table), includes Nos. 76d, 802d, 1521, 2777, 4724 to 4728, 5598, 12416, two 178 and four wood screws, 1 1/4-in., No. 10, for 42-5 and 42-8 Machines.....	2 25
4822	—	Wrench for 1547, 1548 and 1549. Old No. 375 A. & A.....	05
5465	678	Needle Bar for 42-2, 42-3 and 42-4 Machines..	40
5587	—	Knee Lifter complete (Power Table), includes 802d, 2777, 5598, 5607, 5614 and two 178, for 42-2, 42-3 and 42-4 Machines.....	2 00
5596	—	Bell Crank (Knee Lifter).....	05
5598	680	" " 5596 with 5599, 5601 and 5602 (Knee Lifter).....	20
5599	—	Bell Crank Bracket (Knee Lifter).....	08
5601	—	" " Hinge Pin (Knee Lifter).....	01
5602	—	" " Spring " ".....	02
5607	697	Lifting Lever (Knee Lifter) for 42-2, 42-3 and 42-4 Machines.....	20
5607	697	Lifting Lever (Knee Lifter) obsolete, for 42-5 Machine.....	20
5608	679	Presser Bar Lifting Bracket with 453c, for 42-2, 42-3 and 42-4 Machines.....	25
5610	680	Presser Bar Lifting Bracket, obsolete, for 42-5 Machine.....	25
5614	679	Pitman (Knee Lifter) for 42-2, 42-3 and 42-4 Machines.....	08
5682	686	Needle Clamp with 246 and 5691, obsolete, for 42-2, 42-3 and 42-4 Machines, use 4803.....	45
5691	686	Needle Clamp Thread Guide for 5682, obsolete,	10

No.	Plate.	Name.	Each
5751	685	Shuttle (Cylinder), 2½-in. diam., with 14535, for 42-4 and 42-5 Machines.....	6 00
5752	685	Shuttle Frame for 5751.....	2 75
5753	—	“ Driver, obsolete, for 42-4 and 42-5 Machs.	1 25
5754	677	“ Race, includes Nos. 741D, 5755, 5756, 5760, 5938, 5939 and two each 219, 5790 and 5965, for 42-4 and 42-5 Machines.....	3 50
5755	—	Shuttle Race Body for 5754.....	2 00
5756	688	“ “ Cap (right) for 5754.....	10
5757	678	Thread Take-up Cam (steel) with 446c, for 42-4 Machine.....	1 25
5758	678	Thread Take-up Lever with 1819, for 42-4 and 42-5 Machines.....	75
5759	688	Throat Plate for 5995, for 42-4 and 42-5 Machs.	1 25
5760	683	Shuttle Race Cap (left) for 5754.....	10
5761	678	Bobbin Winder Spindle for 5809.....	20
5762	680	“ “ complete, includes Nos. 46D, 190, 5809, 5958 and 11114, for 42-4 and 42-5 Machines.....	95
5763	696	Face Plate for 5797 and 5989, obsolete, for 42-3 Machine.....	75
5764	680	Thread Take-up Cam (steel) with 446c, for 42-3 Machine.....	1 50
5765	—	Thread Take-up Lever with 1819, obsolete....	75
5766	679	Vibrating Presser, obsolete, for 42-3 Machine	2 00
5767	—	“ “ Guide Bracket, obsolete, for 42-3 Machine.....	75
5768	683	Vibrating Presser Hinge Bracket, obsolete, for 42-3 Machine.....	60
5769	686	Thread Eyelet (side of arm) obsolete.....	03
5772	697	Rock Shaft (Knee Lifter Stand).....	12
5773	—	“ “ 5772 with 2768, 2770, 6387, 12243 and two 7539 (Knee Lifter Stand).....	1 10
5774	689	Feed Dog (double), 12 teeth, for 42-2 and 42-3 Machines.....	1 00
5775	689	Throat Plate for 5774 for 42-2 and 42-3 Machs.	1 25
5776	688	Feed Dog for sewing buff wheels for 42-2 Machine.....	1 00
5777	688	Throat Plate for 5776 for 42-2 Machine.....	1 25
5778	696	Oil Cup for 5781.....	55
5779	695	“ “ Pad (felt) for 5781.....	02
5780	695	“ “ Thread Eyelet for 5781.....	01
5781	—	“ “ complete, includes Nos. 211, 5778, 5779, 5780 and 7071 for 42-4, 42-5 and 42-8 Machines.....	60
5783	—	Shuttle, 2½ inches diam., with 5810 for 42-2, 42-3 and 42-8 Machines.....	5 00
5784	684	Shuttle Bobbin Case, includes 591, 592E, 5785, 5789, 5931, 5933 and 5935 for 5783.....	2 50
5785	—	Shuttle Bobbin Case Hinge, includes 5786, 5787 and 5788 for 5784.....	60

No.	Plate	Name	Each
5786	684	Shuttle Bobbin Case Latch for 5784.....	25
5787	684	“ “ “ “ “ Lever for 5784.....	25
5788	684	“ “ “ “ “ Fulcrum Pin for 5784.....	per 100.. 25
5789	684	Shuttle Bobbin Case Position Finger for 5784.	10
5790	686	“ Race Cap Dowel Pin for 5754.....	—
5791	696	Face Plate for 5797 and 5989 for 42-5 and 42-8 Machines.....	75
5792	683	Lifting Presser Foot for 42-5 and 42-8 Machs	40
5793	680	Thread Take-up Cam (steel) with 446c, for 42-5 Machine.....	1 50
5794	683	Vibrating Presser Foot for 42-5 Machine.....	60
5795	686	Tension Wheel for 5797.....	40
5797	—	“ “ complete (wheel), includes 817, 1580, 2103, 5795 and two each 5983 and 5984....	65
5798	682	Vibrating Presser Spring, obsolete, for 42-3 Machine.....	05
5799	686	Thread Guard for 5763 (obsolete).....	01
* 5801	—	Arm for 42-5 and 42-8 Machines.....	6 00
5802	689	Throat Plate for carpet mitres for 5774.....	1 25
5805	—	Knee Lifter complete (Stand), includes 802D, 5598, 5607, 5614, 5773 and two 178, for 42-2, 42-3 and 42-4 Machines.....	1 75
5806	686	Lifting Lever Adjusting Block Hinge Pin, obsolete, for 42-3 Machine.....	01
5809	—	Bobbin Winder Frame complete, includes Nos. 333D, 5761, 5959 to 5961 and 5963 for 5762.....	65
5810	684	Shuttle Bobbin (solid and hardened) for 5783.	25
5811	695	Arm Spool Pin and Thread Eyelet.....	05
5812	694	Feed Dog (double) for 42-8 Machine.....	1 00
5813	694	Throat Plate for 5812.....	1 25
5814	694	Vibrating Presser Foot for 42-8 Machine.....	75
5815	697	Feed Lifting Rock Shaft for 42-8 Machine....	50
5816	694	Lifting Presser Foot for 42-8 Machine.....	40
5817	680	Thread Take-up Cam (steel) with 446c, for 42-8 Machine.....	1 50
5818	—	Knee Lifter complete (Stand), includes 76D, 802D, 1521, 4724 to 4728, 5598, 5773, 12416, two 178 and four wood screws, 1-in., No. 10, for 42-5 and 42-8 Machines.....	2 35
* 5819	—	Arm for 42-3 Machine.....	6 00
5820	675	Face Plate for 5797 and 5989 for 42-3 Mach....	75
5821	675	Lifting Lever for 42-3 Machine.....	1 25
5822	676	“ “ Adjusting Block for 42-3 Mach..	50
5823	676	“ “ “ “ “ Roller for 42-3 Machine.....	12
5824	676	Lifting Lever Adjusting Block Roller Pin for 42-3 Machine.....	05
5825	—	Lifting Lever 5821 with 248, 266D, 5822 to 5824 for 42-3 Machine.....	2 00

No	Plate	Name	Each
5826	676	Lifting Cam for 5764 for 42-3 Machine.....	75
5827	675	Presser Bar Lifting Bracket with 453c, for 42-3 Machine.....	85
5828	675	Thread Take-up Lever with 1819, for 42-3 Machine.....	85
5829	675	Vibrating Presser for 42-3 Machine.....	2 00
5830	676	" " Hinge Bracket with 453c, 42-3 Machine.....	75
5831	676	Vibrating Presser Spring for 42-3 Machine...	05
5832	677	Shuttle Driver for 42-2, 42-3 and 42-3 Machs..	1 25
5833	679	" " " 42-4 and 42-5 Machines....	1 25
5834	697	Oscillating Shaft.....	50
5835	676	Lifting Lever Hinge Bracket for 42-3 Mach...	50
5836	—	" " " " 5835 with 4810, for 42-3 Machine.....	65
5837	676	Vibrating Presser Guide Bracket for 42-3 Mach.	75
5838	—	Shuttle Bobbin Case Latch Spring for 5784...	05
* 5900	—	Bed for 42-2 and 42-3 Machines.....	5 00
5902	677	Feed Bar for 42-2, 42-3 and 42-3 Machines....	40
5903	—	" Dog for canvas work (double), distance between rows $\frac{1}{2}$ -in., obsolete, for 42-2 Machine.....	1 00
5905	690	Feed Dog for tent work for 42-3 Machine....	1 00
5906	690	" " " canvas work for 42-2 Machine..	1 00
5907	697	" Forked Connection for 42-2 and 42-3 Machines.....	60
5908	697	Feed Lifting Rock Shaft for 42-2 and 42-3 Machines.....	45
5909	—	Feed Lifting Rock Shaft 5908 with 3166 for 42-2 and 42-3 Machines.....	85
5910	697	Feed Rock Shaft for 42-2 and 42-3 Machines..	55
5911	—	" " " 5910 with 5913 for 42-2 and 42-3 Machines.....	75
5913	682	Feed Rock Shaft Crank for 5911.....	20
5914	677	Oscillating Rock Shaft for 1878, obsolete....	1 00
5915	—	" Shaft for 5936, obsolete.....	50
5917	683	" " Collar with 455c.....	20
5919	682	" " Crank with 1878 and 1520, obsolete.....	65
5921	689	Presser Foot (hinged) for 42-2 Machine.....	2 00
5922	—	" " " Bracket for 5921.....	1 00
5923	686	" " " " Hinge Pin for 5921.....	01
5924	—	Presser Foot Plate for 5921.....	1 00
5926	—	Shuttle, 2 $\frac{1}{2}$ -in. diam., with 5927, obsolete, for 42-2, 42-3 and 42-3 Machines, use 5783....	5 00
5927	684	Shuttle Bobbin for 5926, obsolete, use 5810....	25
5929	684	" " Case for 5926, includes 591, 592E, 5930 to 5932, 5935 and two 5933, obsolete, use 5784.....	2 50
5930	684	Shuttle Bobbin Case Latch for 5929, obsolete..	25
5931	684	" " " " Spring for 5929, obsolete.....	05

No	Plate	Name	Each
5932	684	Shuttle Bobbin Case Position Finger for 5929, obsolete.....	10
5933	684	Shuttle Bobbin Case Position Finger Rivet for 5784.....per 100...	25
5934	684	Shuttle Body for 5783.....	2 50
5935	684	" Tension Spring for 5784.....	30
5936	—	" Driver, obsolete, for 42-2, 42-3 and 42-3 Machines.....	1 25
5937	—	Shuttle Race complete, includes 741D, 5938 to 5942 and two each 219, 399 and 5965, ob- solete, use 5972, for 42-2, 42-3 and 42-3 Machines.....	3 50
5938	677	Shuttle Race Back for 5754 and 5972.....	60
5939	677	" " " Spring for 5754 and 5972....	30
5940	—	" " Body, obsolete, for 5937.....	2 00
5941	677	" " Bridge, " " ".....	—
5942	677	" " Cap for 5972.....	30
5943	677	" " Frame with 5944.....	2 50
5944	686	" " " Steady Pin for 5943.....	01
5945	—	" " Slide.....	40
5946	677	" " " 5945 with 5947 and two 240D	50
5947	682	" " " Spring for 5946.....	10
5948	—	Throat Plate for 5903, obsolete, for 42-2 Mach.	1 25
5950	690	" " " 5905.....	1 25
5951	690	" " " 5906.....	1 25
5954	678	Thread Take-up Lever with 1819 for 42-2 and 42-3 Machines.....	75
5957	—	Bobbin Winder Frame complete, includes 333D and 5959 to 5963 for 5974.....	60
5958	680	Bobbin Winder Bracket for 5762 and 5974....	20
5959	680	" " Frame for 5809 and 5957.....	15
5960	678	" " Friction Wheel (leather) for 5809 and 5957.....	10
5961	678	Bobbin Winder Friction Wheel Washer for 5809 and 5957.....	05
5962	678	Bobbin Winder Spindle for 5957.....	15
5963	678	" " " Flange for 5809 and 5957.....	06
5964	687	Roller Presser complete, 1 $\frac{1}{2}$ -in., includes Nos. 176, 440, 1549, 1875, 2205, 3223, 6535 and two each 316 and 1547, for 42-4 Machine..	1 30
5965	686	Shuttle Race Back Dowel Pin.....per 100..	10
5966	—	Oscillating Shaft Crank for 42-2, 42-3 and 42-3 Machines.....	30
5967	681	Oscillating Shaft Crank 5966 with 1513 and 1885.....	75
5968	686	Oscillating Shaft Crank Roller and Screw Stud Cap Screw Washer.....	02
5969	697	Crank Connecting Rod.....	80
5970	679	Oscillating Rock Shaft (steel) for 1885.....	1 00
5971	687	Presser Foot (long shank) for 42-4 Machine...	75

No.	Plate	Name	Each
5972	677	Shuttle Race, includes 741d, 5988, 5989, 5942, 5973 and two each 219 and 5965 for 42-2, 42-3 and 42-8 Machines.	3 50
5973	—	Shuttle Race Body for 5972.	2 00
5974	680	Bobbin Winder complete, includes 46d, 190, 5957, 5968 and 11114 for 42-2, 42-3 and 42-8 Machines.	90
5975	698	Drip Pan (Stand) with four wood screws, $\frac{3}{8}$ -in., No. 5.	30
5976	—	Drip Pan (Power Table) with four wood screws, $\frac{3}{8}$ -in., No. 5.	30
5977	696	Balance Wheel (two spec.) for Loose Wheel Attachment 5981.	1 75
5978	696	Driving Flange.	50
5979	688	" " Latch.	10
5980	688	" " Spring.	05
5981	—	Loose Wheel Attachment complete, Nos. 5977 and 5983.	2 50
5982	696	Face Plate for 5797 and 5989 for 42-3 and 42-4 Machines.	75
5983	686	Tension Washer (felt) for 5797.	01
5984	686	" " (steel) for 5797.	01
5985	—	" Wheel, obsolete, use 5795.	—
*5986	—	" Flange, obsolete.	—
5987	—	" Hub, obsolete.	—
5988	—	" complete (wheel), includes 817, 1560, 2108, 5985 and two each 5983 and 5984, obsolete, use 5797.	—
5989	—	Thread Retainer complete, includes 418d, 1562, 10141 and two 2455.	15
5990	681	Presser Bar Lifter for 42-2, 42-3 and 42-4 Machines.	25
5991	686	Thread Take-up Spring.	08
*5992	—	Bed for 42-4, 42-5 and 42-8 Machines.	5 00
5993	—	Driving Flange 5978 with 186, 830d, 5979 and 5980 for Loose Wheel Attachment 5981.	75
5994	679	Feed Bar for 42-4 and 42-5 Machines.	30
5995	688	" Dog (leather), 8 teeth, for 42-4 and 42-5 Machines.	40
5996	697	Feed Lifting Rock Shaft for 42-4 and 42-5 Machines.	50
5997	679	Feed Lifting Rock Shaft Crank Fork with 157 $\frac{1}{2}$ for 42-4 and 42-5 Machines.	40
5998	679	Feed Lifting Rock Shaft Crank with 1813 and two 172 $\frac{1}{2}$ for 42-4 and 42-5 Machines.	50
5999	—	Oscillating Shaft Crank for 1885, for 42-4 and 42-5 Machines.	30
6000	—	Oscillating Shaft Crank 5999 with 1513 and 1885, for 42-4 and 42-5 Machines.	75
6107	696	Arm Shaft for 5977.	1 50
6109	696	" " " 3011.	1 50

No.	Plate	Name	Each
6337	697	Rock Shaft Lifting Bracket with two 3560 (Knee Lifter).	20
6535	—	Roller Arm for 5964.	20
7071	695	Oil Cup Pad Screw Washer for 5781.	01
7539	697	Rock Shaft Hanger with two wood screws, 1-in., No. 10 (Knee Lifter).	08
7958	695	Pitman Stud Pin (Stand).	01
10141	695	Thread Retainer Spring.	01
11114	692	Bobbin Winder Spring for 5974 and 5762.	08
11165	695	Oscillating Rock Shaft Oil Pad for 5970.	01
11742	695	Pitman Washer (Stand).	01
12000	683	Shuttle Cylinder Hinge Pin for 5751.	02
12001	685	" " Latch for 5751.	15
12002	685	" " " Pin for 5751.	01
12008	685	" " " Spring for 5751.	03
12098	685	" " " for 5751.	2 50
12095	685	" Tension Spring for 5751.	40
12242	697	Rock Shaft Hanger with two wood screws, 1 $\frac{1}{4}$ -in., No. 10 (Knee Lifter, Power Table).	08
12243	697	Rock Shaft Lifting Bracket Hook (Knee Lifter, Stand).	15
12296	686	Thread Eyelet (side of arm).	02
12416	681	Lifting Lever Connecting Rod Joint (Knee Lifter) for 42-5 and 42-8 Machines.	08
13017	678	Thread Take-up Cam (steel), with 4460 for 42-2 Machine.	1 25
*13019	—	Arm, obsolete, for 42-2 and 42-4 Machines, use 4287.	4 50
14585	685	Shuttle Bobbin (solid and hardened) for 5751.	25
25001	698	Back Leaf Bracket. (Stand).	10
25002	698	" " Scroll Bracket.	15
25003	698	" " Sliding Hinge.	25
25010	698	Band Wheel Crank.	15
25029	695	Belt Hook.	01
25057	698	End Leaf Support.	25
25060	698	" " " Button.	08
25064	698	Leg.	1 60
25070	695	Machine Cushion Tack (rubber).	01
25074	698	Pitman (adjustable).	25
25075	695	" Adjusting Screw Nut Washer.	01
25082	698	Treadle.	65
25086	698	Wrench for 1507 and 1510.	10
25123	—	Pitman Adjusting Block.	02
25133	698	Band Wheel (two-speed), 10 and 12-in. diam., with 25010 (Stand).	3 00
25136	—	Belt, size $\frac{3}{8}$ -in., length, 62 $\frac{1}{2}$ inches, with 25029 (Stand).	30
25143	695	End Leaf Support Lever Hinge Pin (Stand).	01
25151	698	Back Leaf Sliding Hinge Plate for 25003.	05
25166	698	Brace with three each 2970 and 1507 (Stand).	1 70

No.	Plate	Name	Each
25168	680	End Leaf Support Bracket (Stand).....	10
25169	—	“ “ “ Lever “ .....	15
25226	—	Stand complete with 25136 (Table not included) 9 88	
25867	—	Guide (cloth). Old No. 559 A. & A.....	10
25868	—	“ “ for carpet mitres. Old No. 560 A. & A.....	40
25952	—	Oiler with Cap and Spout. Old No. 325 A. & A.	05
25953	—	“ 25952 filled with oil. Old No. 326 A. & A.....	08
25954	—	Oiler Spout. Old No. 327 A. & A.....	01
26026	—	Screw Driver (Machine). Old No. 398 A. & A.	10
26027	—	“ “ (Shuttle Tension) with wood handle. Old No. 395, A. & A.....	05

THE SINGER MANUFACTURING COMPANY use and recommend  
exclusively the WILLIMANTIC SPOOL COTTON.



PLATE 675—ONE-HALF SIZE

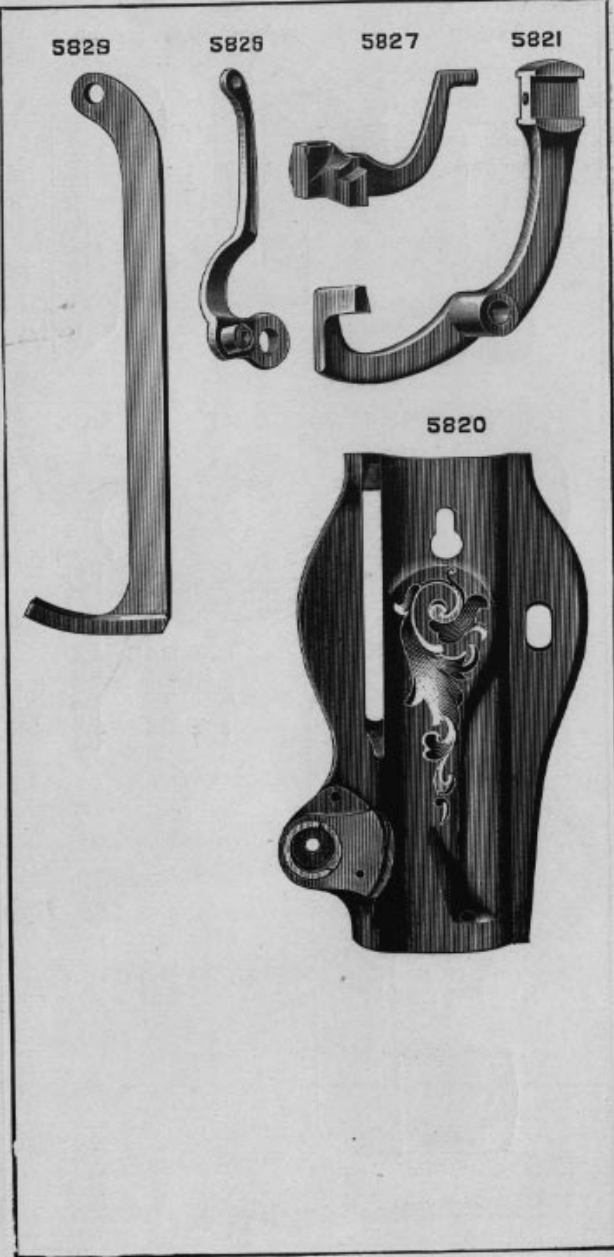

PLATE 676—FULL SIZE

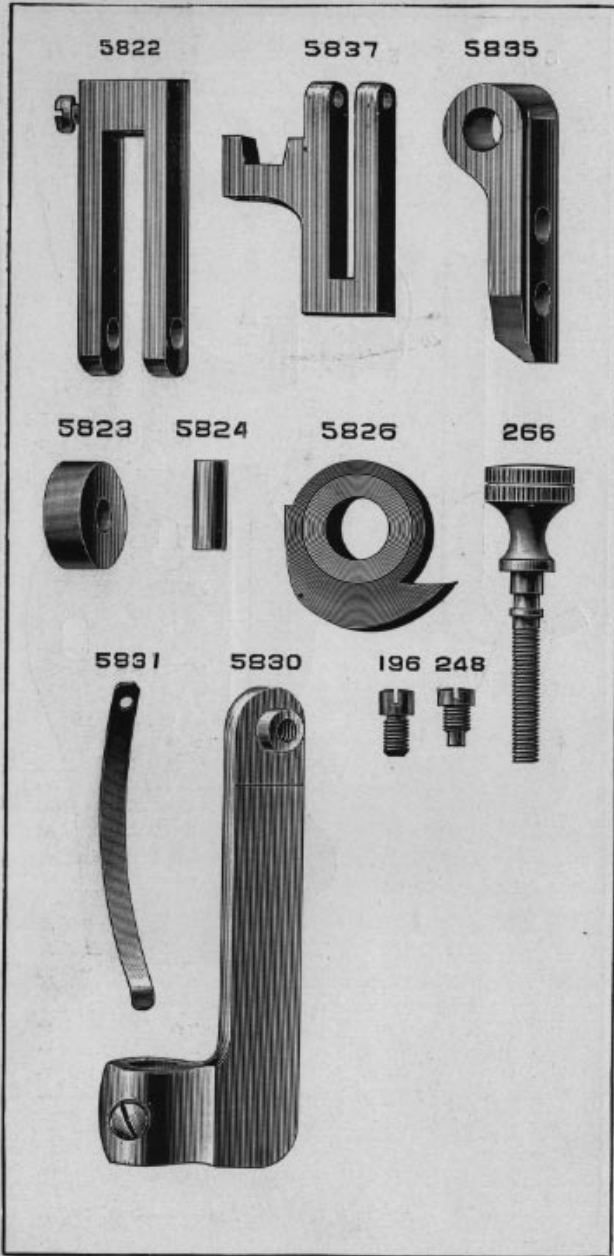

PLATE 677—ONE-HALF SIZE

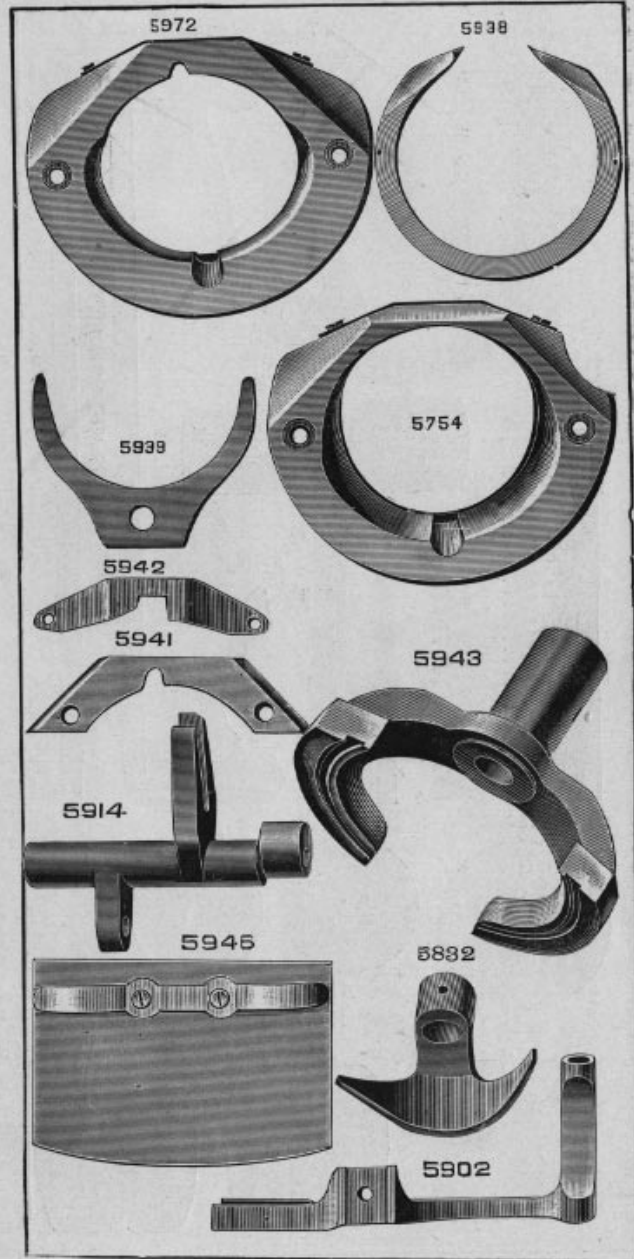

PLATE 678—ONE-HALF SIZE

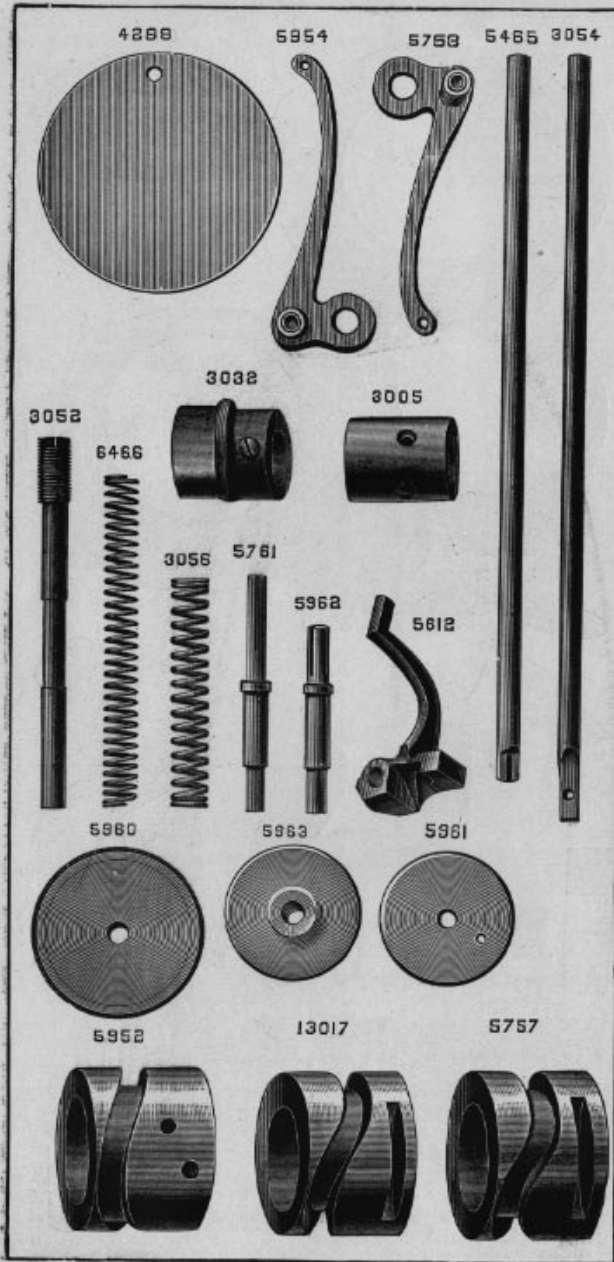

PLATE 679—ONE-HALF SIZE

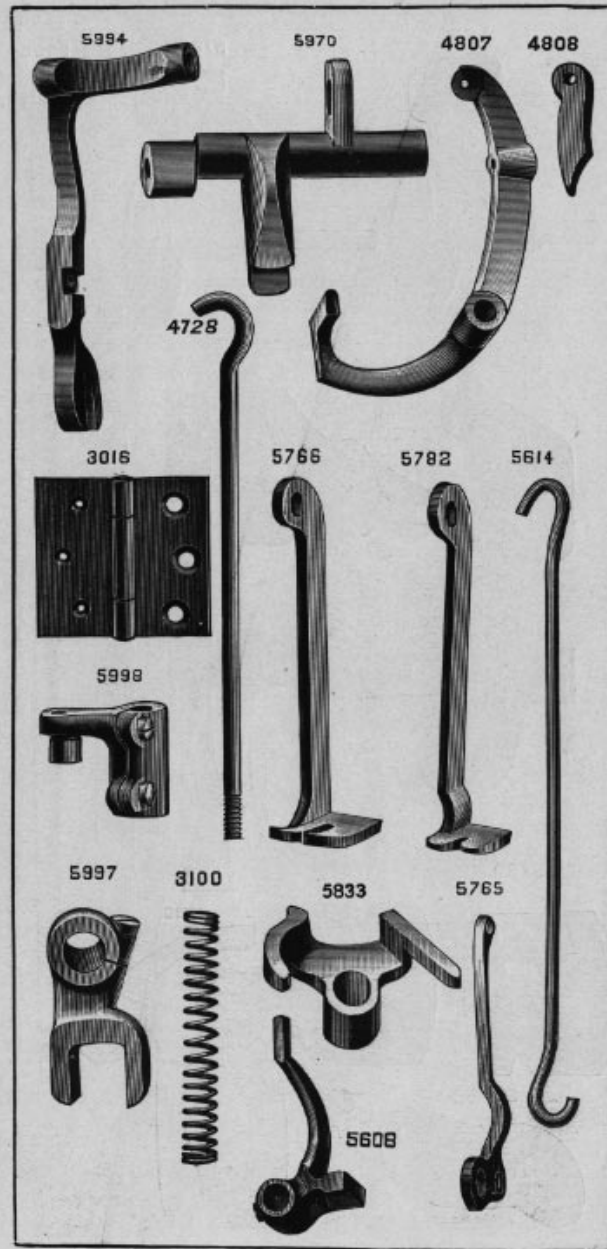



PLATE 680—ONE-HALF SIZE

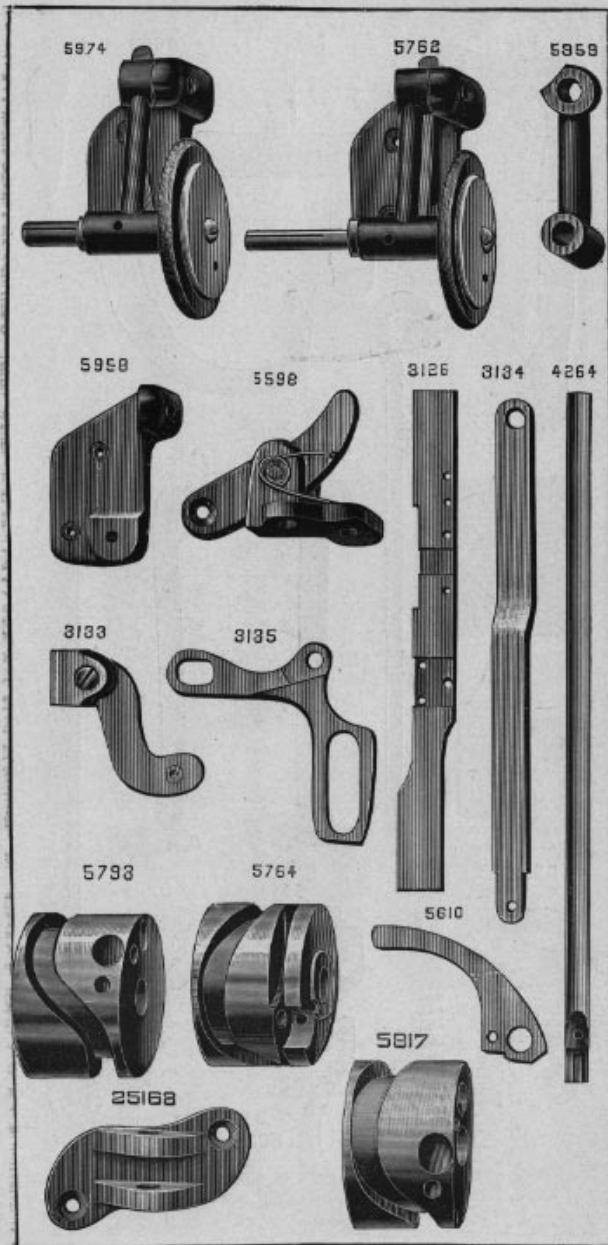

PLATE 681—FULL SIZE

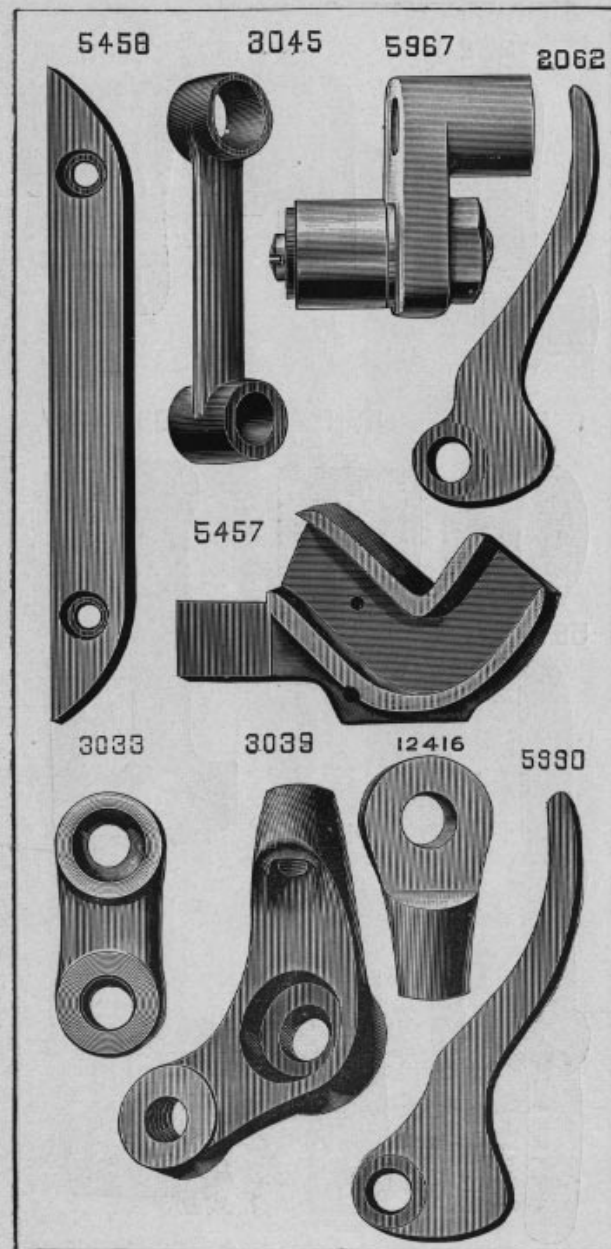

PLATE 682—FULL SIZE

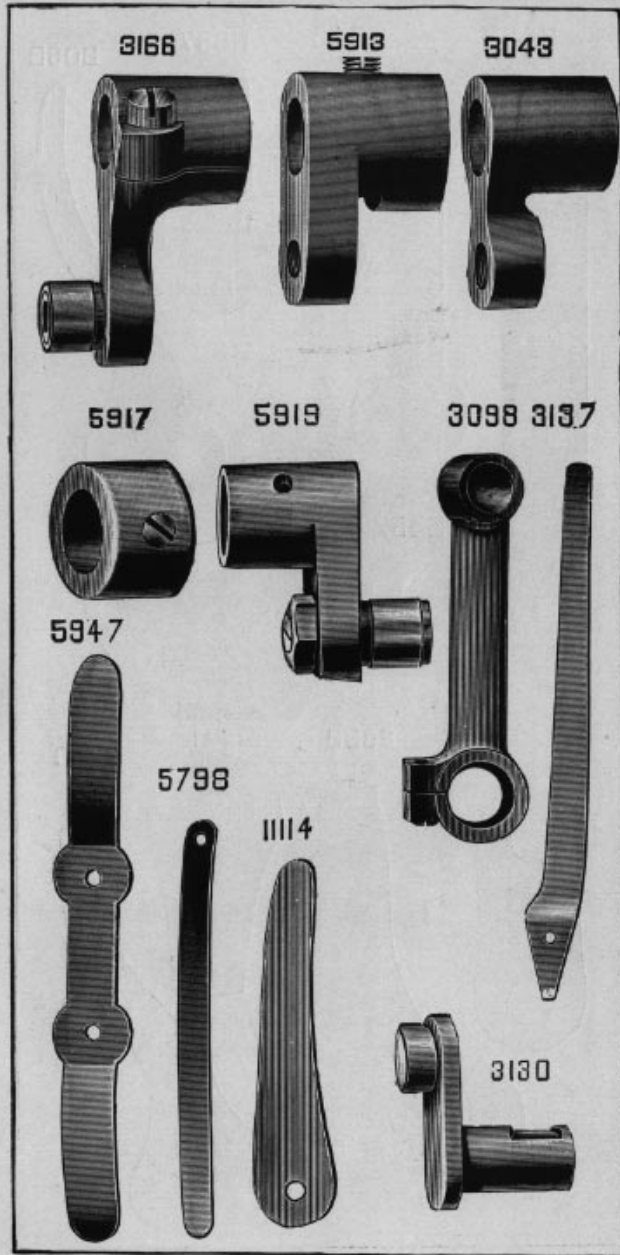
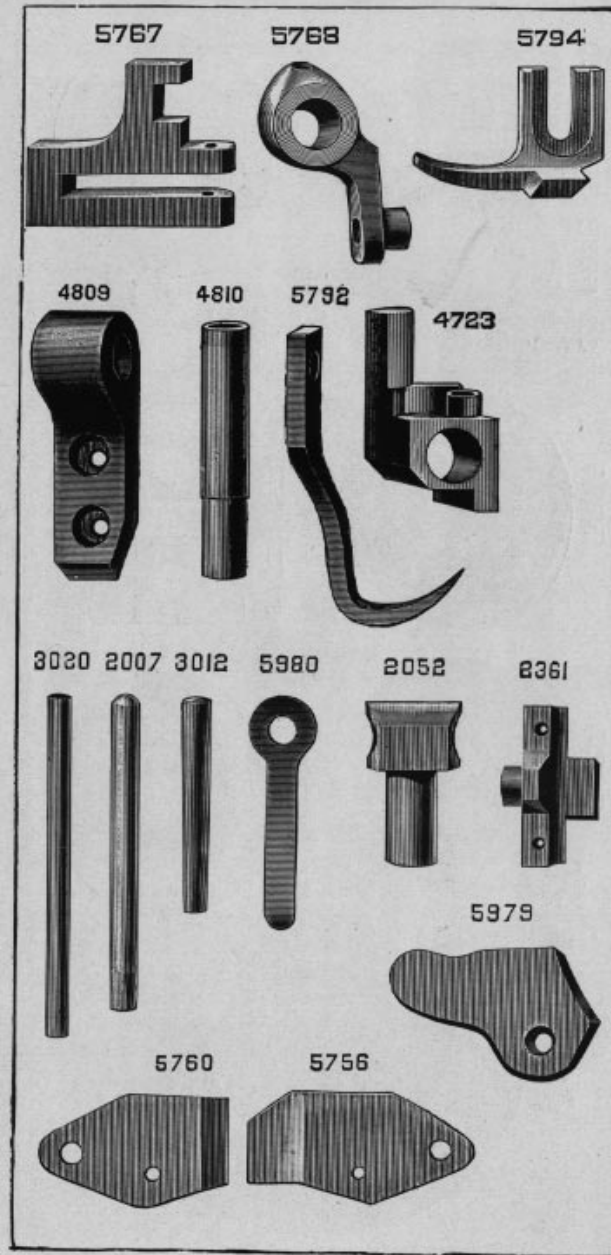

PLATE 683—FULL SIZE





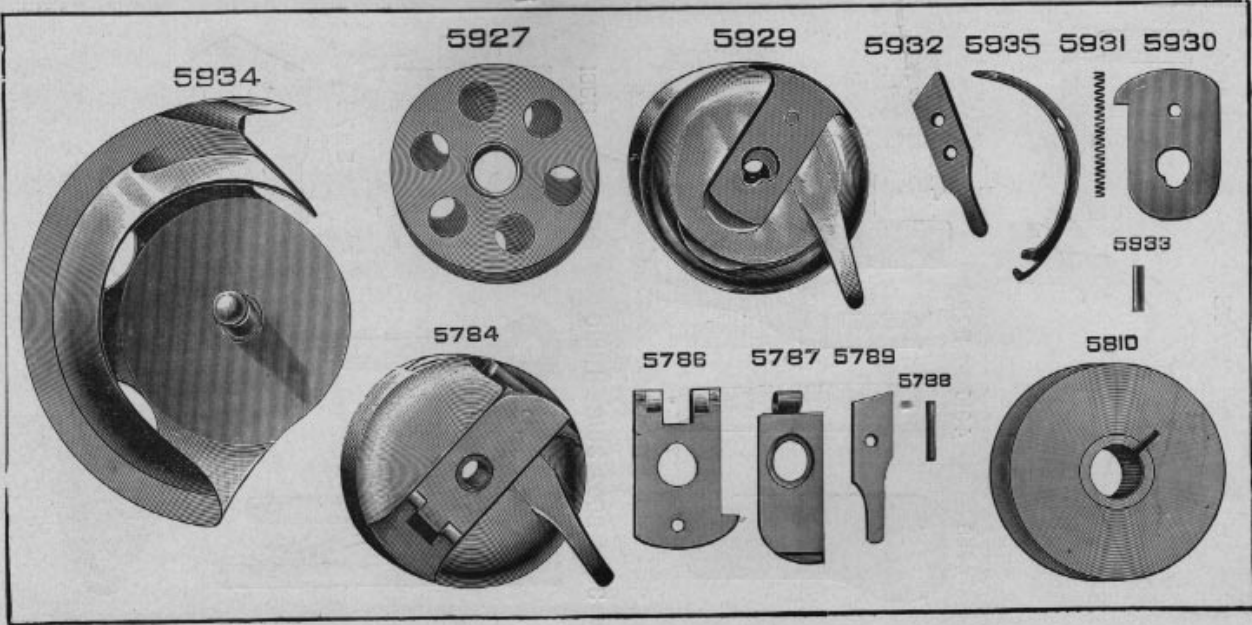

PLATE 684—FULL SIZE

PLATE 685—FULL SIZE

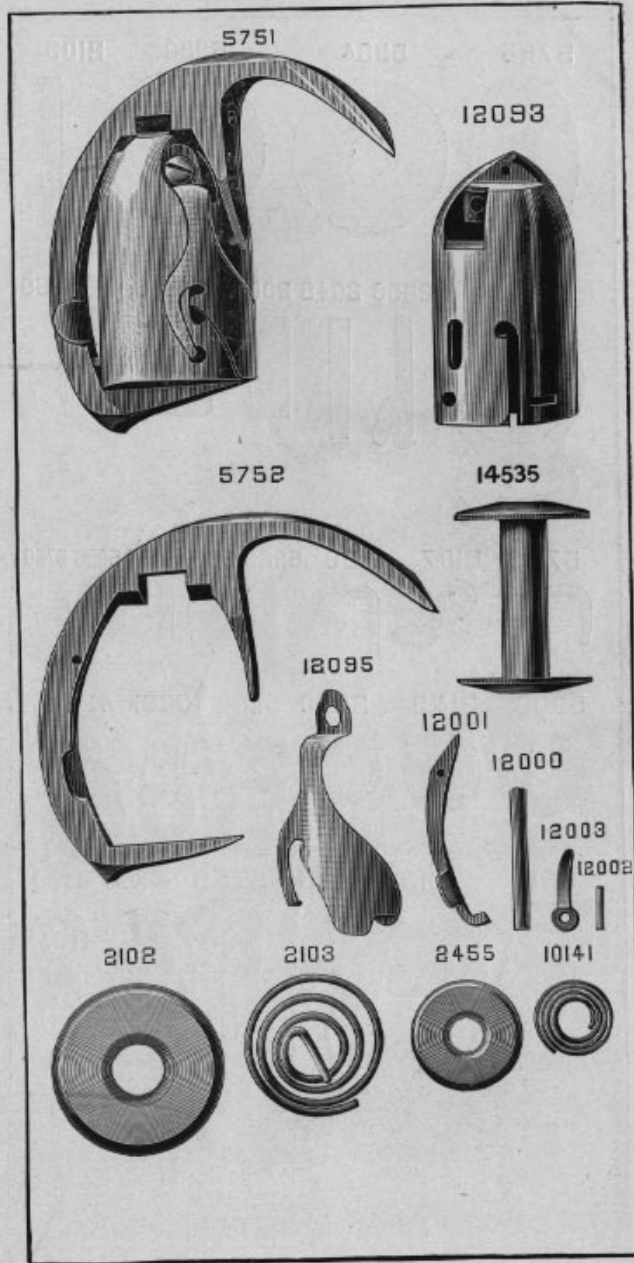
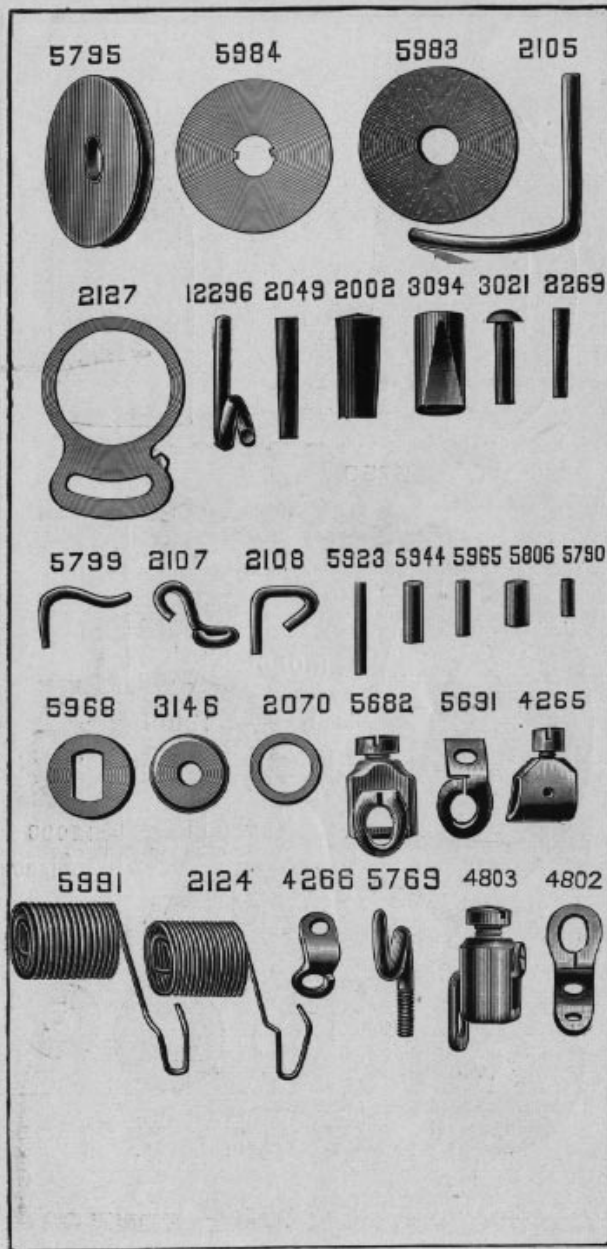

PLATE 686—FULL SIZE



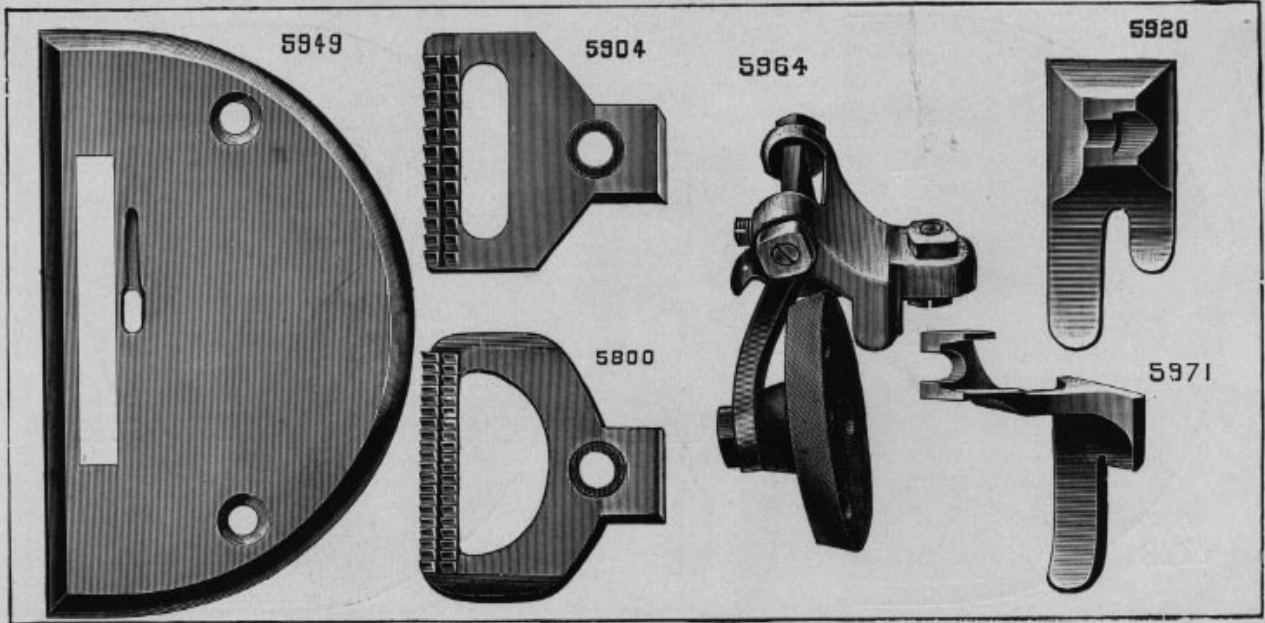

PLATE 687—FULL SIZE



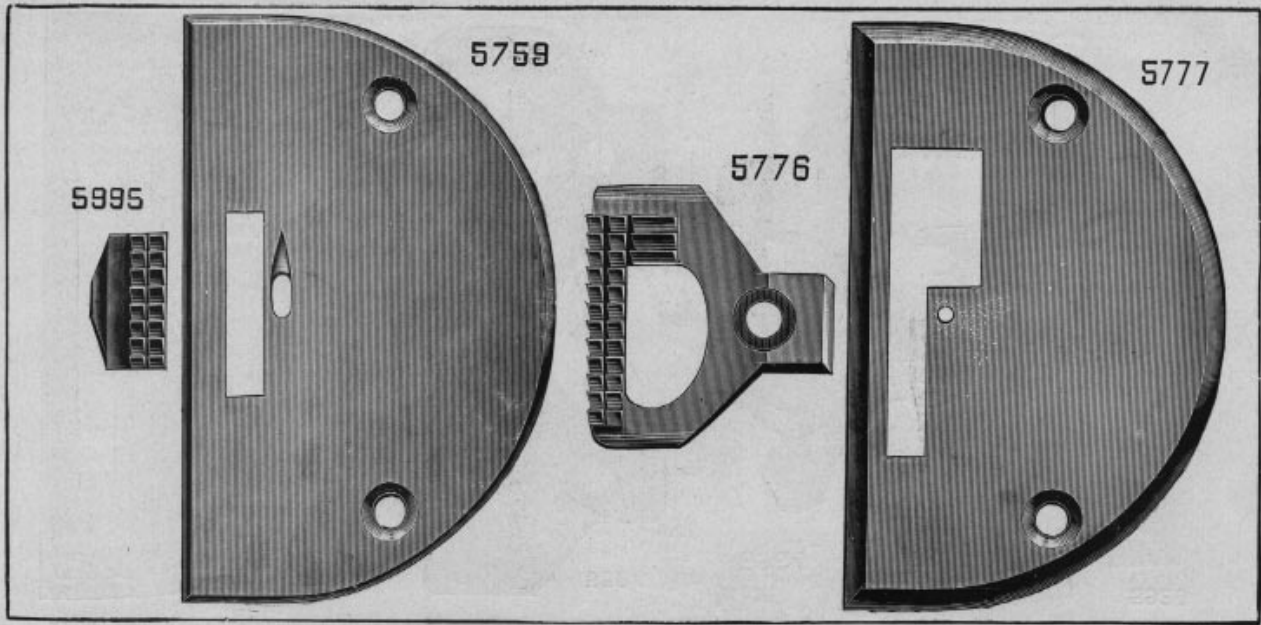

PLATE 688—FULL SIZE

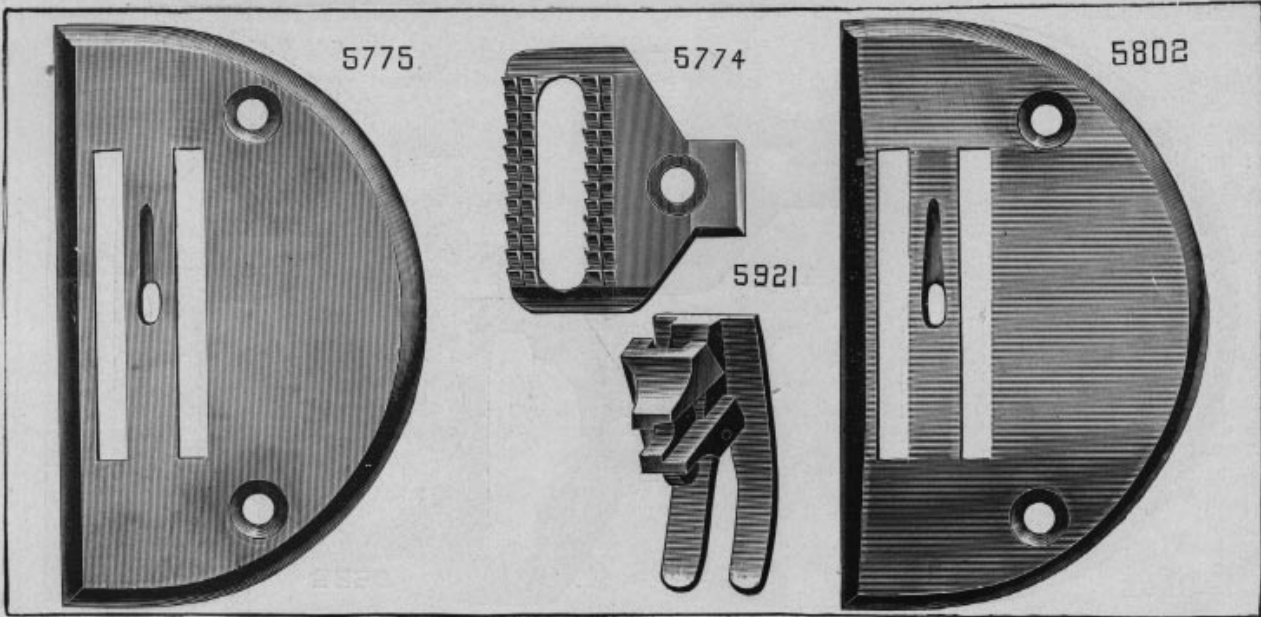
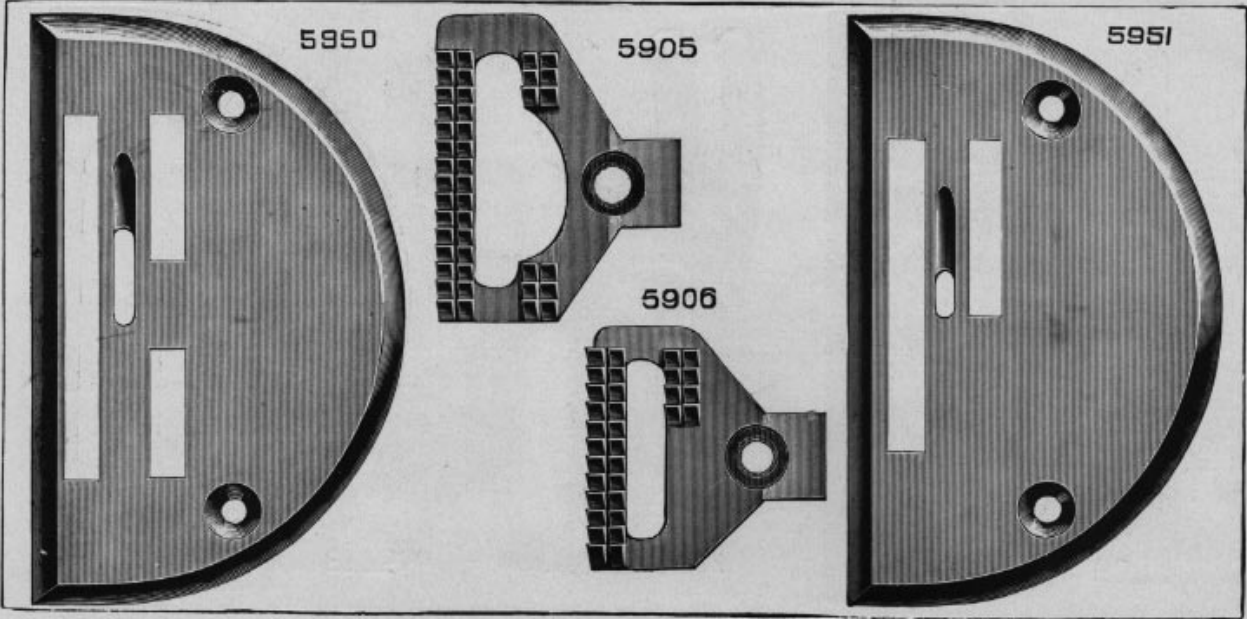

PLATE 689—FULL SIZE



5950

5905

5951

5906

PLATE 690—FULL SIZE



PLATE 691—FULL SIZE

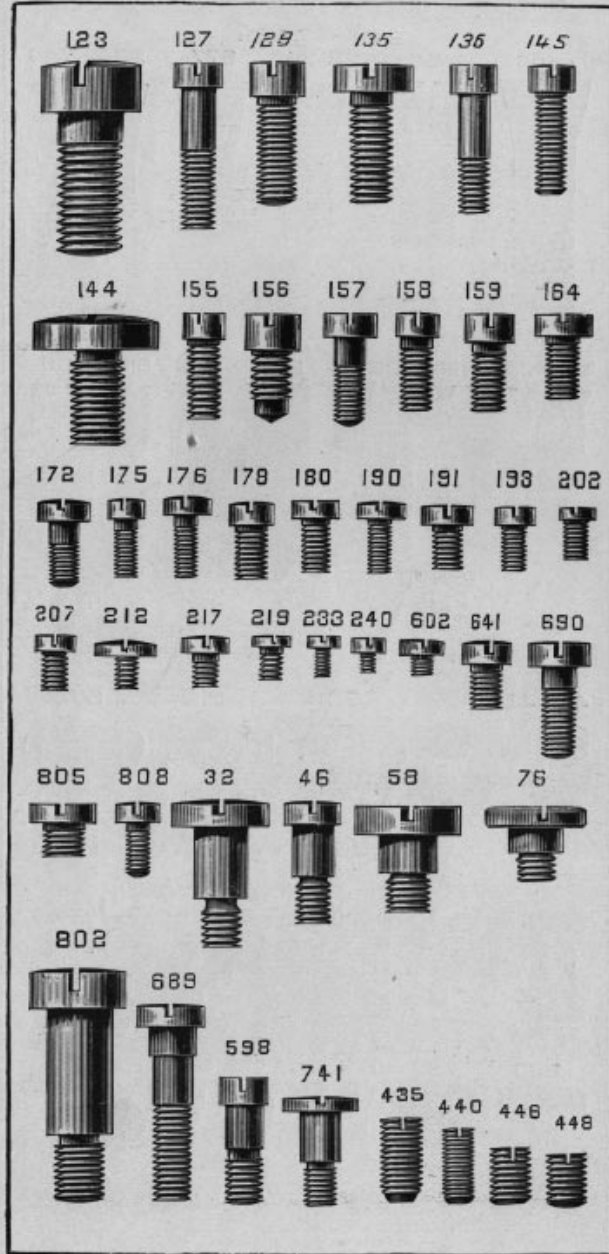

PLATE 692—FULL SIZE

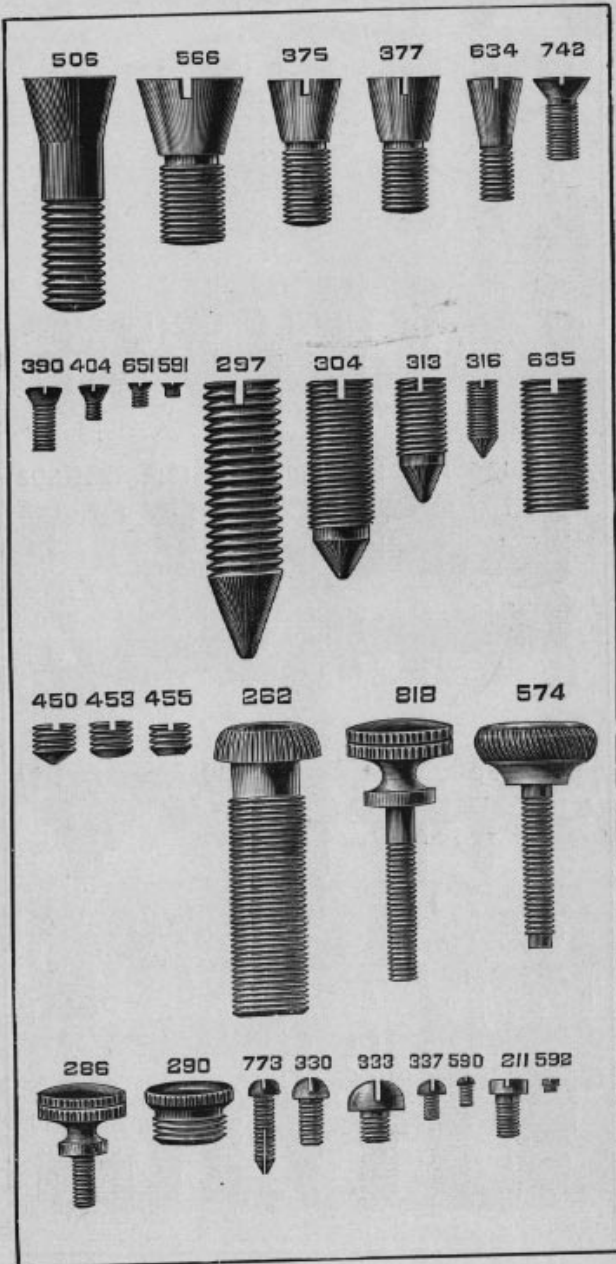
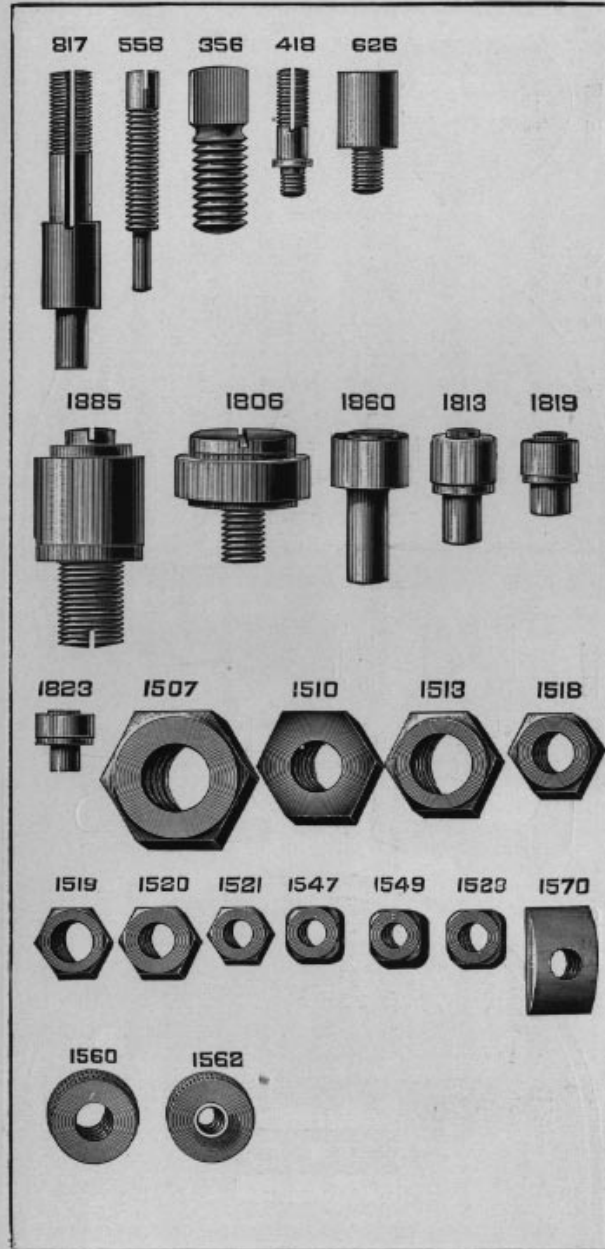

PLATE 693—FULL SIZE



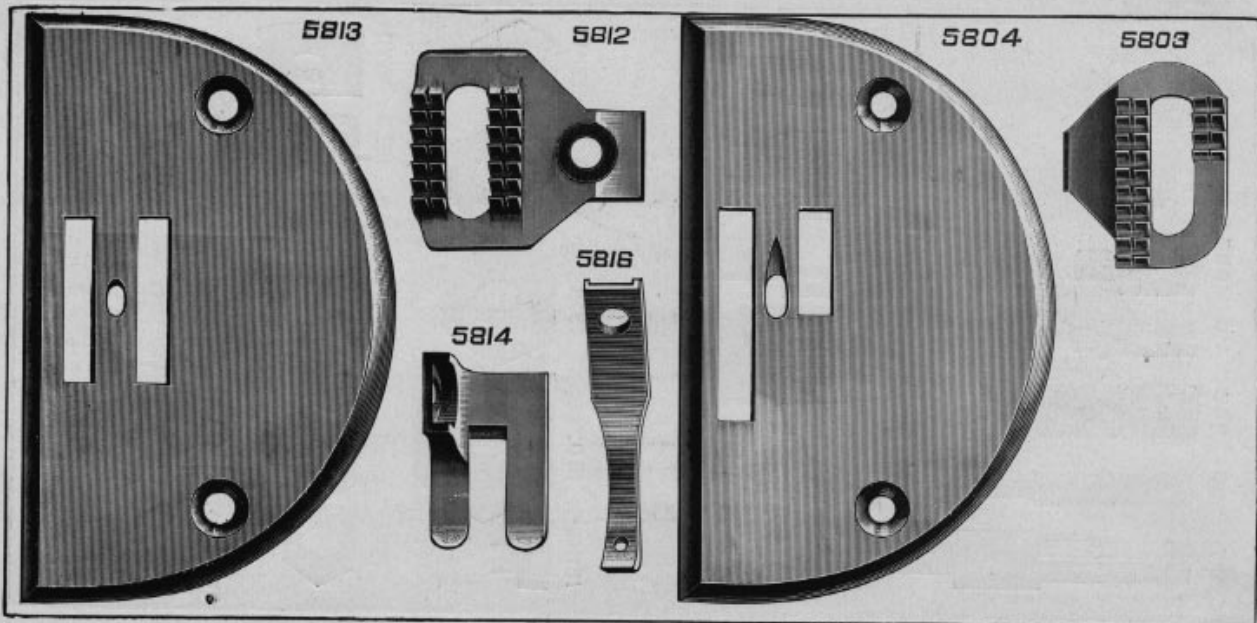

PLATE 694—FULL SIZE



PLATE 695—FULL SIZE

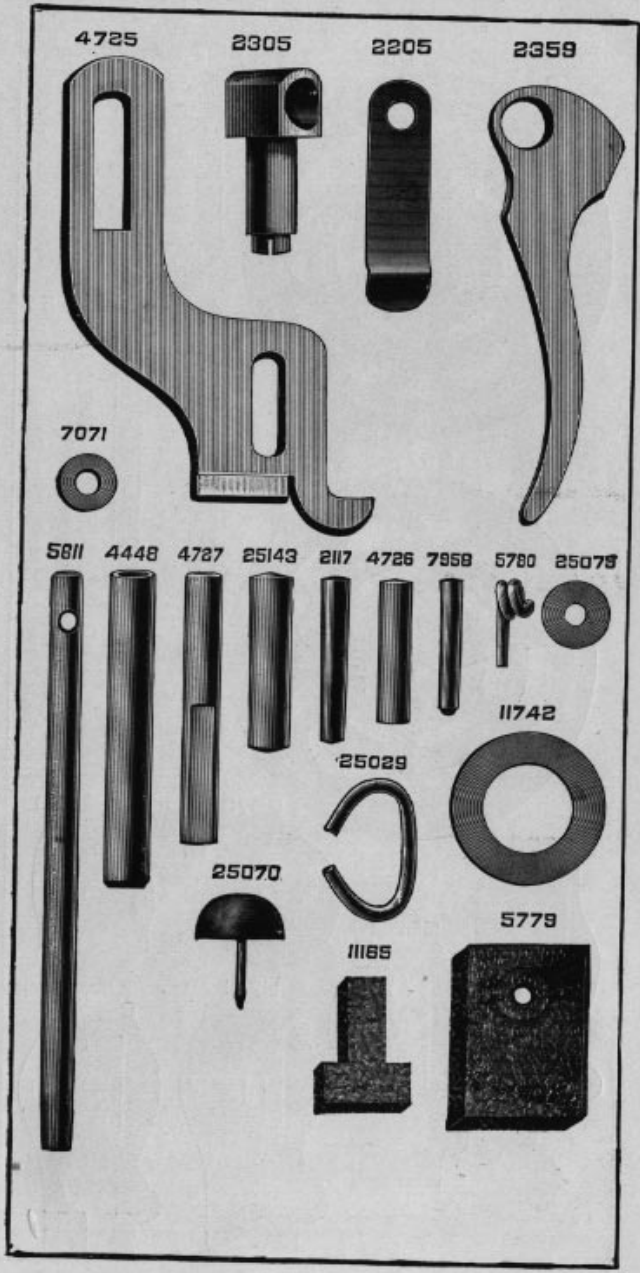

PLATE 696—ONE-FOURTH SIZE

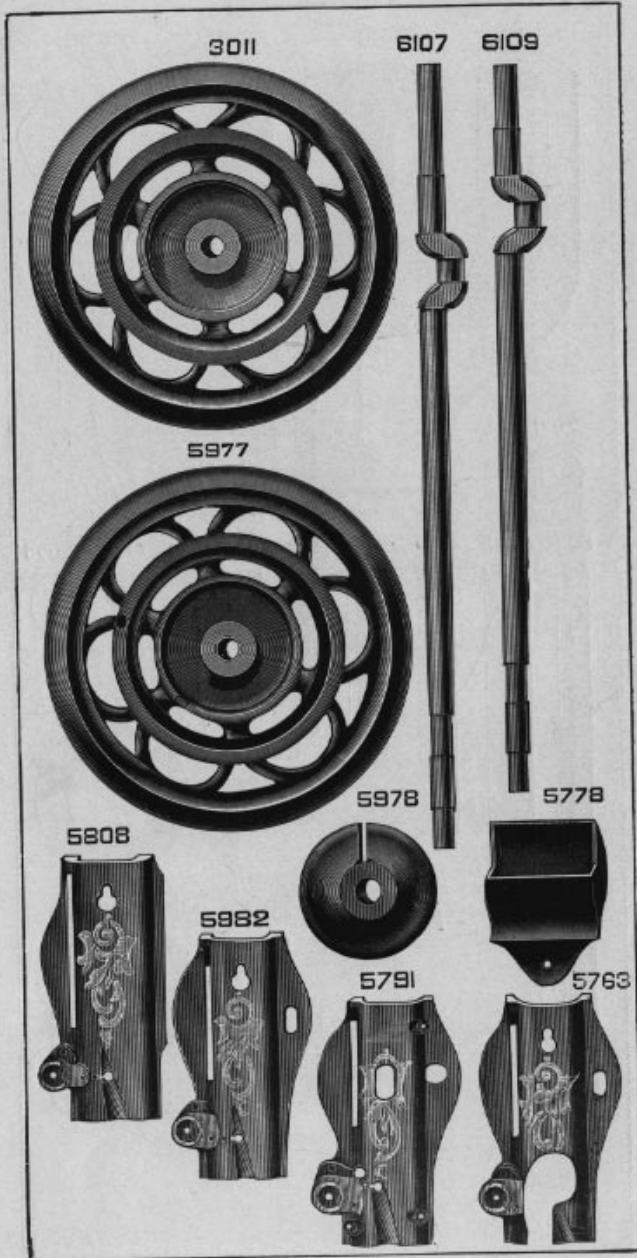
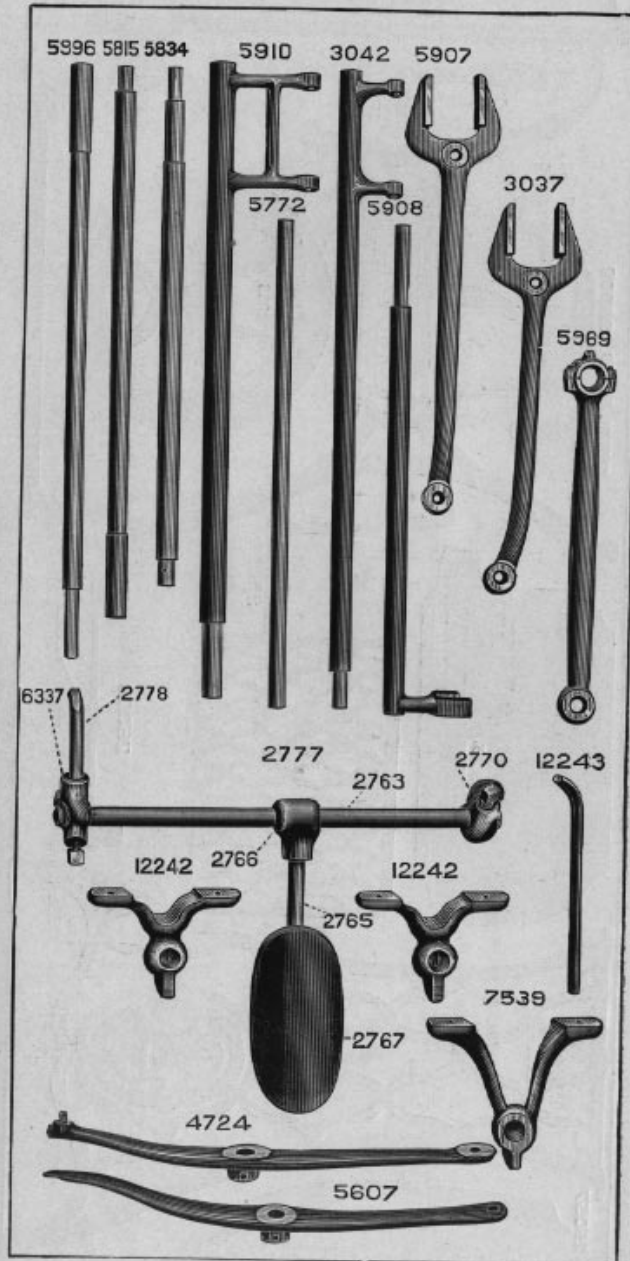

PLATE 697—ONE-FOURTH SIZE



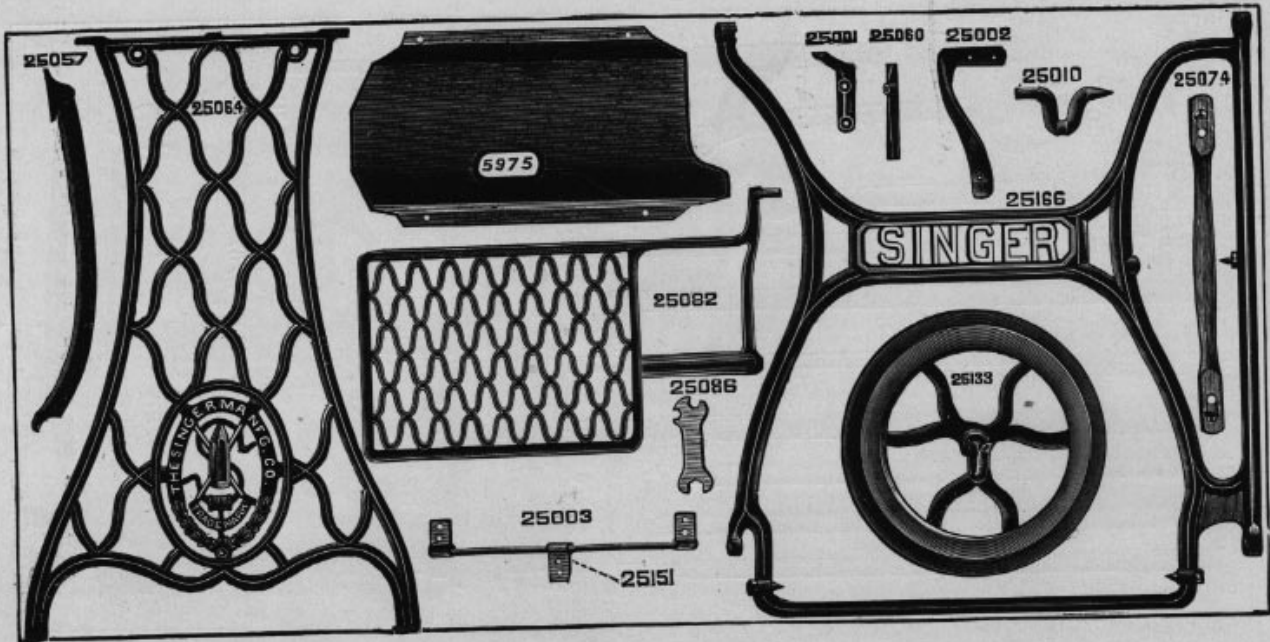

PLATE 698—ONE-EIGHTH SIZE